



TEXAS INSTRUMENTS

9900

**TMS9918A/TMS9928A/TMS9929A
Video Display Processors**



MICROPROCESSOR SERIES™

IMPORTANT NOTICES

Texas Instruments reserves the right to make changes at any time in order to improve design and to supply the best product possible.

TI cannot assume any responsibility for any circuits shown or represent that they are free from patent infringement.

Copyright © 1982
Texas Instruments Incorporated

TABLE OF CONTENTS

SECTION	PAGE
1. INTRODUCTION	1-1
1.1 Description	1-1
1.2 Features	1-1
1.3 Typical Applications	1-2
1.4 Acronyms and Glossary	1-3
2. ARCHITECTURE	2-1
2.1 CPU Interface	2-1
2.1.1 CPU Interface Control Signals	2-1
2.1.2 CPU Write to VDP Register	2-1
2.1.3 CPU Write to VRAM	2-3
2.1.4 CPU Read from VDP Status Register	2-4
2.1.5 CPU Read from VRAM	2-4
2.1.6 VDP Interrupt	2-5
2.1.7 VDP Initialization	2-5
2.2 Write-Only Registers	2-5
2.2.1 Register 0	2-5
2.2.2 Register 1	2-5
2.2.3 Register 2	2-7
2.2.4 Register 3	2-7
2.2.5 Register 4	2-7
2.2.6 Register 5	2-7
2.2.7 Register 6	2-7
2.2.8 Register 7	2-7
2.2.9 Setup Values for VDP Registers 2 through 6	2-7
2.3 Status Register	2-11
2.3.1 Interrupt Flag (F)	2-11
2.3.2 Coincidence Flag (C)	2-11
2.3.3 Fifth Sprite Flag (5S) and Number	2-11
2.4 Video Display Modes	2-12
2.4.1 Graphics I Mode	2-17
2.4.2 Graphics II Mode	2-19
2.4.3 Multicolor Mode	2-21
2.4.4 Text Mode	2-23
2.4.5 Sprites	2-25
2.4.6 A Step-by-Step Approach to Create Patterns and Sprites	2-29
3. VDP INTERFACES AND OPERATION	3-1
3.1 VDP/VRAM Interface	3-1
3.1.1 VRAM Interface Control Signals	3-1
3.1.2 VRAM Memory Types	3-1
3.1.3 VDP to DRAM Address Connections	3-1
3.2 VRAM Memory Address Derivation	3-3
3.3 VRAM Addressing Example	3-4
3.4 Monitor Interfaces	3-5
3.4.1 TMS9918A Monitor Interface	3-5
3.4.2 TMS9928A/9929A Monitor Interface	3-6
3.5 TMS9918A External VDP Operation	3-7
3.6 Oscillator and Clock Generation	3-8
3.6.1 TMS9918A Color Phase Generation	3-8
3.6.2 Video Sync and Control Generation	3-8

TABLE OF CONTENTS (continued)

SECTION	PAGE
3.7 VDP Terminal Assignments	3-9
3.7.1 TMS9918A Terminal Assignments	3-9
3.7.2 TMS9928A/9929A Terminal Assignments	3-11
3.7.3 TMS9918A/9928A/9929A Crystals	3-12
4. DEVICE APPLICATIONS	4-1
4.1 VDP to TMS9900 Interface	4-1
4.2 TMS9918A/9928A/9929A Interface	
4.2.1 TM990 (TMS9918A/9928A/9929A) Parts List	4-4
4.2.2 Composite Video Output	4-4
4.2.3 Oscillator and Timing	4-4
4.2.4 VRAM Connections	4-5
4.3 VDP Initialization	4-5
4.4 Typical Software Program	4-6
4.4.1 General	4-6
4.5 TMS9900 Software SubRoutines	4-6
5. TMS9918A/9928A/9929A ELECTRICAL SPECIFICATIONS	5-1
5.1 Absolute Maximum Ratings	5-1
5.2 Recommended Operating Conditions	5-1
5.3 Electrical Characteristics	5-2
5.4 Timing Requirements	5-4
5.5 Switching Characteristics	5-5

LIST OF APPENDICES

APPENDIX	PAGE
A ASCII Character Set	A-1
B Choosing VRAM Memory	B-1
C Pattern and Screen Worksheets	C-1

LIST OF ILLUSTRATIONS

FIGURE	PAGE
1-1 System Block Diagram	1-2
2-1 VDP Block Diagram	2-2
2-2 VDP to CPU Interface	2-3
2-3 VDP Registers	2-6
2-4 VDP Display Planes (Definition)	2-12
2-5 VDP Display Planes (First 32 Planes)	2-13
2-6 TMS9928A/9929A Signal Waveforms for Multiple VDP Operation	2-14
2-7 Using Color Difference Signals to Mix External Color Difference Type Source	2-15
2-8 Using Color Difference Signals to Mix External Video Sources	2-15
2-9 Pattern Graphics Name Table Mapping	2-17
2-10 Graphics I Mode Mapping	2-18
2-11 Pattern Display Mapping	2-18
2-12 Graphics II Mode Mapping	2-20
2-13 Pattern Display Mapping	2-21
2-14 Multicolor List Mapping	2-21
2-15 Multicolor Block Display	2-22
2-16 Multicolor Mode Mapping	2-23
2-17 Text Mode Name Table Pattern Positions	2-23
2-18 Mapping of VRAM into the Pattern Plane in Text Mode	2-24
2-19 Sprite Attribute Table Entry	2-25
2-20 Sprite Mapping	2-26
2-21 Size 1 Sprite Mapping	2-28
3-1 VRAM Interface	3-2
3-2 VDP-VRAM Memory Allocation	3-5
3-3 Composite Video Pull-Down Circuit	3-5
3-4 Use of TMS9928A/9929A with Different Monitors	3-6
3-5 Cascading Two TMS9918A VDPs	3-7
3-6 Cascading Two TMS9918A/9929A VDPs	3-7
4-1 Minimum System Interface to TMS9900	4-1
4-2 TMS9918A/9928A/9929A Interface	4-2
4-3 TM990 (TMS9918A/9928A/9929A) Demo Board	4-3
4-4 RF Modulator Connection	4-4
4-5 External Frequency Source	4-5
4-6 VDP Register Initialization Procedure	4-5
5-1 Load Circuit for COMVID (All Devices) and R-Y, Y, B-Y Switching Characteristics (TMS9928A/9929A)	5-9
5-2 Load Circuits for All Outputs Except COMVID, R-Y, Y, B-Y	5-9
5-3 CPU-VDP Write Cycle (All Devices)	5-10
5-4 CPU-VDP Read Cycle (All Devices)	5-10
5-5 VRAM Write Cycle	5-11
5-6 VRAM Read Cycle	5-11
5-7 External Clock Timing Waveform	5-12
5-8 TMS9918A COMVID Horizontal Timing	5-12
5-9 TMS9918A Vertical Timing	5-12

LIST OF ILLUSTRATIONS (continued)

FIGURE		PAGE
5-10	TMS9928A/9929A Y Horizontal Timing	5-13
5-11	TMS9928A/9929A R-Y Horizontal Timing	5-13
5-12	TMS9928A/9929A B-Y Horizontal Timing	5-14
5-13	TMS9929A Vertical Timing	5-14

LIST OF TABLES

TABLE		PAGE
2-1	CPU/VDP Data Transfers	2-3
2-2	Memory Access Delay Times	2-4
2-3	Color Assignments	2-17
2-4	Graphics I Mode Color Table	2-19
2-5	Sprite Pattern Formats	2-25
3-1	VDP to DRAM Address Connections	3-1
3-2	Pattern Graphics Address Location Tables	3-3
3-3	Screen Display Parameters	3-8
4-1	VDP Port Addresses for Figure 4-1	4-1

1. INTRODUCTION

1.1 Description

The TMS9918A/9928A/9929A video display processors (VDP) are N-channel MOS LSI devices used in video systems where data display on a raster-scanned home color television set or color monitor is desired. These devices generate all necessary video, control, and synchronization signals and also control the storage, retrieval, and refresh of display data in the dynamic screen refresh memory. The interfaces to the microprocessor, refresh memory, and the TV require a minimum of additional electronics for the TMS9918A.

In Section 1.4, there is a list of acronyms and a glossary of terms used in this manual.

The TMS9928A/9929A VDPs are functionally identical to the TMS9918A except that the NTSC color encoding circuitry has been removed and replaced with luminance and color difference signals. The TMS9918A is pin-for-pin compatible with the TMS9928A/9929A, except for three pins, the composite video output, the external video input and the CPU clock output. These pins are replaced with the Black/White luminance and composite sync (Y) output and two color difference pins, Blue (B-Y) and Red (R-Y) outputs, respectively. The color difference outputs allow the user to generate Red-Green-Blue (R-G-B) drive for direct color gun control, or composite video for use with NTSC or PAL video color monitor. However, to connect these three outputs to a R-G-B or monitor requires additional R-G-B or encoder circuitry.

The TMS9918A/9928A have a 525-line format for U.S. televisions while the TMS9929A has a 625-line format for use with the European PAL system.

The VDP has four video display modes: Graphics I, Graphics II, Multicolor and Text mode. The Text mode provides twenty-four 40-character rows in two colors and is intended to maximize the capacity of the TV screen to display alphanumeric character. The Multicolor mode provides an unrestricted 64×48 color-dot display employing 15 colors plus transparent. The Graphics I mode provides a 256×192 pixel display for generating pattern graphics in 15 colors plus transparent. The Graphics II mode is an enhancement of Graphics I mode, allowing it to generate more complex color and pattern displays. The four video display modes are described in detail in Section 2.4.

The video display consists of 35 planes: external VDP, backdrop, pattern plane, and 32 Sprite Planes. The planes are vertically stacked with the external VDP being the bottom or innermost plane. The backdrop plane is the next plane followed by the pattern plane that contains Graphics I and Graphics II patterns with the 32 Sprite Planes as the top planes.

The TMS9918A/9928A/9929A VDPs use either a 4K, 8K, or 16K-type low-cost dynamic memory (TMS4027, TMS4108, TMS4116) for storage of the display parameters.

The TMS9918A, TMS9928A, and TMS9929A interface identically to the host microprocessor making them software compatible. Thus, all references to VDP in this document apply to all three devices, except where noted.

1.2 FEATURES

- Single-chip solution for interfacing color TVs (excluding Random-Access Memory (RAM) and Radio Frequency (RF) modulator (TMS9918A only))
- 256×192 resolution on TV screen
- 15 unique colors plus transparent
- General 8-bit bidirectional interface to Central Processor Unit (CPU)
- Direct wiring to 4K, 8K, or 16K dynamic RAM memories
- Automatic and transparent refresh of dynamic RAMs
- Multiple VDP systems capability
- External VDP input capability (TMS9918A only)
- Composite video output (TMS9918A only)
- Unique planar representation for 3D simulation
- Standard 40-pin package
- Color difference outputs allow RGB drive — TMS9928A/9929A

1.3 TYPICAL APPLICATIONS

- Color computer terminals
- Home computers
- Drafting/design aids
- Teaching aids
- Industrial process monitoring
- Home educational systems
- Animation aids
- European 625-line TV (TMS9929A only)

The following example of a typical application may help introduce the user to the TMS9918A VDP. Figure 1-1 is a block diagram of a typical application. Each of the concepts presented in the example is described more fully in later sections of this manual.

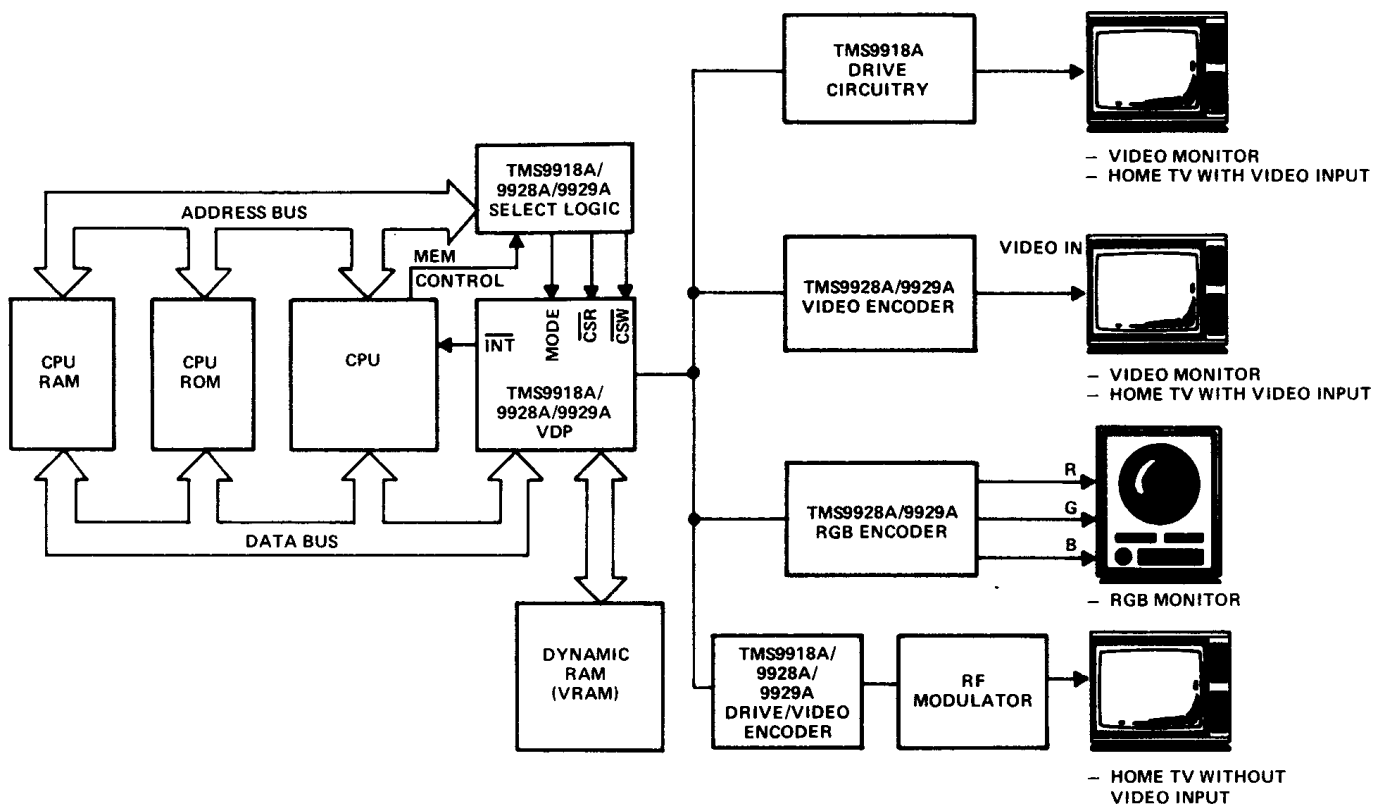

FIGURE 1-1 — SYSTEM BLOCK DIAGRAM

The VDP basically has three interfaces: CPU, color monitor, and dynamic refresh RAM (VRAM), the contents of which define the TV image. The TMS9918A also has eight write-only registers and a read-only status register.

The VDP communicates with the CPU via an 8-bit bidirectional data bus. Three control lines, decoded from the CPU address and enable lines, determine interpretation of the bus. Through the bus, the CPU can write to VRAM, read from VRAM, write to VDP registers, and read the VDP status. The VDP also generates an interrupt signal after every refresh of the TV display.

The dynamic RAM interface consists of direct wiring of eight $4K \times 1$, $8K \times 1$, or $16K \times 1$ dynamic RAS/CAS-type RAMs to the VDP. The amount of RAM required is dependent upon the features selected for use in the application.

The interface to the monitor can consist of either wiring the TMS9918A's composite video output pin (suitably buffered) to the input of a color or black-and-white monitor, or using an appropriate RF modulator to feed the signal into a TV antenna terminal. The TMS9928A/9929A require additional encoder circuitry to interface to a RGB or to a composite video monitor.

The VDP operates in four modes, and each one can affect the way the VRAM is mapped onto the television screen. In Graphics I and II modes, characters are mapped onto the screen in 8×8 pixel blocks, yielding 24 lines of 32 blocks (pattern positions) each. In Text mode, there are 24 lines of 40 blocks, each of which is 6×8 pixels. In Multicolor mode, there are 48 lines of 64 blocks, each of which is composed of 4×4 picture elements (pixels), all of one solid color. In addition to these, sprites can be superimposed onto the television image in Graphics I, II, and Multicolor mode. Furthermore, signals entering the TMS9918A through the external VDP input can be used as a background to the TMS9918A.

ACRONYMS AND GLOSSARY

B-Y	Blue color difference output
COMVID (Composite Video)	Contains luminance, chrominance and all sync pulse necessary for horizontal and vertical timing
CAS	Column Address Strobe
CPU	Central Processor Unit
CSR	CPU from VDP read select
CSW	CPU to VDP write select
CPUCLK	XTAL — 3
GROMCLK	XTAL — 24
LSB	Least Significant Bit
LSI	Large Scale Integration
MOS	Metal Oxide Semiconductor
MHz	Megahertz
MSB	Most Significant Bit
NTSC	National Television Standards Committee which specifies television signal standards for the USA
PAL	Phase Alternating Line
Pixel	Picture Element — the smallest point on the TV screen that can be independently controlled.
RAM	Random-Access Memory
RAS	Row-Address Strobe
RASTER	The area in which an image is reproduced
RF	Radio Frequency
R-G-B	Red-Green-Blue
ROM	Read-Only Memory
R/W	Read/Write
R-Y	Red color difference output
Sprite	An object whose pattern is relative to a specified X,Y coordinate and whose position can therefore be controlled by that coordinate with a positional resolution of one pixel
VDP	Video Display Processor
VRAM	Video RAM; refers to the dynamic RAMs that connect to the VDP and whose contents define the TV image
Y	Black/white luminance and composite sync

2. ARCHITECTURE

The TMS9918A video display processor (VDP) is designed to provide a simple interface between a microprocessor and a raster-scanned color television. The TMS9928A/9929A VDPs are designed as a simple interface between a microprocessor, and R-G-B monitor or video encoder which produces the video for a video monitor. Figure 2-1 is a block diagram of the major portions of the VDP architecture interfaces to the VDP, CPU, VRAM, and color television.

2.1 CPU INTERFACE

The VDP interface to the CPU using an 8-bit bidirectional data bus, three control lines, and an interrupt is shown in Figure 2-2. Through this interface the CPU can conduct four operations:

- (1) Write data bytes to VRAM
- (2) Read data bytes from VRAM
- (3) Write to one of the eight VDP write-only registers
- (4) Read the VDP Status Register.

Each of these operations requires one or more data transfers to take place over the CPU/VDP data bus interface. The interpretation of the data transfer is determined by the three control lines of the VDP.

NOTE

The CPU can communicate with the VDP simultaneously and asynchronously with the VDP's TV screen refresh operations. The VDP performs memory management and allows periodic intervals of CPU access to VRAM even in the middle of a raster scan.

2.1.1 CPU Interface Control Signals

The type and direction of data transfers are controlled by the CSW, CSR, and MODE inputs. CSW is the CPU to VDP write select. When it is active (low), the eight bits on CD0-CD7 are strobed into the VDP. CSR is the CPU from VDP read select. When it is active (low), the VDP outputs eight bits on CD0-CD7 to the CPU. CSW and CSR should never be simultaneously low at the same time. If both are low, the VDP outputs data on CD0-CD7 and latches in invalid data.

MODE determines the source or destination of a read or write data transfer. MODE is normally tied to a CPU low order address line (A14 for TMS9900).

2.1.2 CPU Write to VDP Register

The VDP has eight write-only registers and one read-only status register. The write-only registers control the VDP operation and determine the way in which VRAM is allocated. The status register contains interrupt, sprite coincidence and fifth sprite status flags.

Each of the eight VDP write-only registers can be loaded using two 8-bit data transfers from the CPU. Table 2-1 describes the required format for the two bytes. The first byte transferred is the data byte, and the second byte transferred controls the destination. The MSB of the second byte must be a 1. The next four bits are 0s, and the lowest three bits make up the destination register number. The MODE input is high for both byte transfers.

To rewrite the data in an internal register after a byte of data has already been loaded, the status register must be read so that internal CPU interface logic is reinitialized and will accept the next byte as data and not as a register destination. This situation may be encountered in interrupt-driven program environments. Whenever the status of VDP write parameters is in question, this procedure should be used.

NOTE

The CPU address is destroyed by writing to the VDP register.

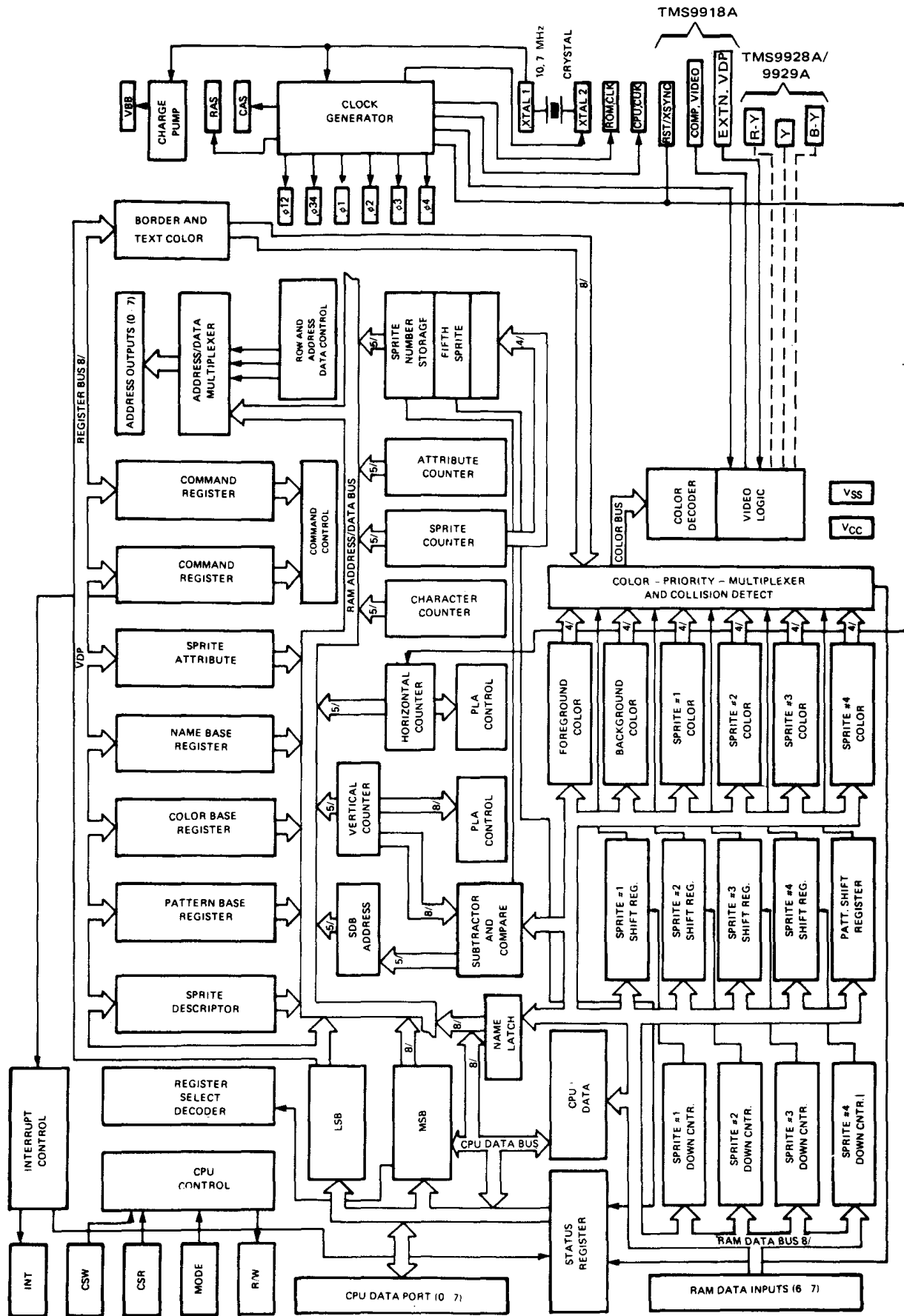

FIGURE 2-1 - VDP BLOCK DIAGRAM

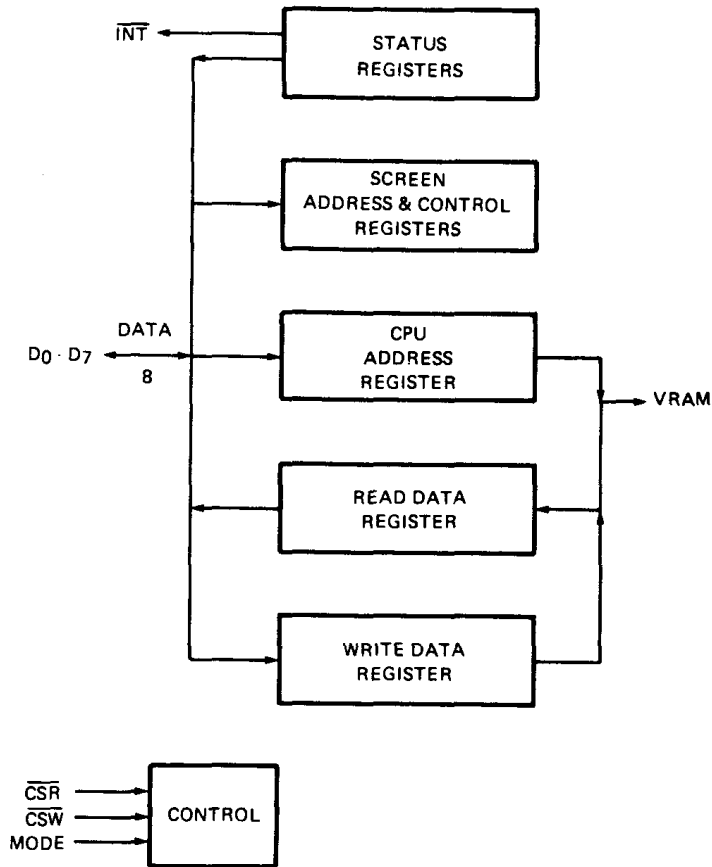

FIGURE 2-2 – VDP TO CPU INTERFACE

2.1.3 CPU Write to VRAM

The CPU transfers data to the VRAM through the VDP using a 14-bit autoincrementing address register. The address register setup requires 2-byte transfers. A 1-byte transfer is then required to write the data to the addressed VRAM byte. The address register is then autoincremented. Sequential VRAM writes require only 1-byte transfers since the address register is already set up. During setup of the address register, the two MSBs of the second address byte must be 0 and 1 respectively. MODE is high for both address transfers and low for the data transfer. CSW is used in all transfers to strobe the 8 bits into the VDP. See Table 2-1.

TABLE 2-1 – CPU/VDP DATA TRANSFERS

OPERATION	BIT								CSW	CSR	MODE
	0	1	2	3	4	5	6	7			
WRITE TO VDP REGISTER											
BYTE 1 DATA WRITE	D ₀	D ₁	D ₂	D ₃	D ₄	D ₅	D ₆	D ₇	0	1	1
BYTE 2 REGISTER SELECT	1	0	0	0	0	RS ₀	RS ₁	RS ₂	0	1	1
WRITE TO VRAM											
BYTE 1 ADDRESS SETUP	A ₆	A ₇	A ₈	A ₉	A ₁₀	A ₁₁	A ₁₂	A ₁₃	0	1	1
BYTE 2 ADDRESS SETUP	0	1	A ₀	A ₁	A ₂	A ₃	A ₄	A ₅	0	1	1
BYTE 3 DATA WRITE	D ₀	D ₁	D ₂	D ₃	D ₄	D ₅	D ₆	D ₇	0	1	0
READ FROM VDP REGISTER											
BYTE 1 DATA READ	D ₀	D ₁	D ₂	D ₃	D ₄	D ₅	D ₆	D ₇	1	0	1
READ FROM VRAM											
BYTE 1 ADDRESS SETUP	A ₆	A ₇	A ₈	A ₉	A ₁₀	A ₁₁	A ₁₂	A ₁₃	0	1	1
BYTE 2 ADDRESS SETUP	0	0	A ₀	A ₁	A ₂	A ₃	A ₄	A ₅	0	1	1
BYTE 3 DATA READ	D ₀	D ₁	D ₂	D ₃	D ₄	D ₅	D ₆	D ₇	1	0	0

2.1.4 CPU Read from VDP Status Register

The CPU can read the contents of the status register with a single-byte transfer. MODE is high for the transfer. CSR is used to signal the VDP that a read operation is required.

2.1.5 CPU Read from VRAM

The CPU reads from the VRAM through the VDP using the autoincrementing address register. A 1-byte transfer is then required to read the data from the addressed VRAM byte. The address register is then autoincremented. Sequential VRAM data reads require only a 1-byte transfer since the address register is already set up. During setup of the address register, the two MSBs of the second address byte must be 0. By setting up the address this way, a read cycle to VRAM is initiated and read data will be available for the first data transfer to the CPU. (See Table 2-1). MODE is high for the address byte transfers and low for the data transfers. The VDP requires approximately 8 microseconds to fetch the VRAM byte following the last data transfer and 2 microseconds following address setup.

The CPU interacts with VRAM memory through the VDP. The amount of time necessary for the CPU to transfer a byte of data to or from VRAM memory can vary from 2 to 8 microseconds. Once the VDP has been told to read or write a byte of data to or from VRAM it takes approximately 2 microseconds until the VDP is ready to make the data transfer. In addition to this 2 microsecond delay, the VDP must wait for a CPU access window; i.e., the period of time when the VDP is not occupied with memory refresh or screen display and is available to read or write data.

The worst case time between windows occurs during the Graphics I or Graphics II mode when sprites are being used. During the active display, CPU windows occur once every 16 memory cycles giving a maximum delay of 6 microseconds (a memory cycle takes about 372 nanoseconds). In the Text mode the CPU windows occur at least once out of every three memory cycles or a worst case delay of about 1.1 microseconds. Finally, in the Multicolor mode, CPU windows occur at least once out of every four memory cycles.

If the user needs to access memory in 2 microseconds, two situations occur where the time waiting for an access window is effectively zero. Both of these are independent of the display mode being used.

The first situation occurs when the blank bit of register 1 is 0. With this bit low, the entire screen will show only border color and the VDP does not have to wait for a CPU access window at any time.

The second situation occurs when the VDP is in the vertical refresh mode. The VDP issues an interrupt output at the end of each active area. This signal indicates that the VDP is entering the vertical refresh mode and that for the next 4.3 milliseconds there is no waiting for an access window. If the user wants the CPU to access memory during this interval, it is necessary for the controlling CPU to monitor the interrupt output of the VDP (the CPU can either poll this output or use it as an interrupt input).

The program that monitors the interrupt output must allow for its own delays in responding to the interrupt signal and recognize how much time it has left during the 4300 microsecond refresh period. The CPU must write a 1 to the interrupt enable bit of Register 1 in order to enable the interrupt for each frame, and then read the status register each time an interrupt is issued to clear the interrupt output. A summary of these delay times is presented in Table 2-2.

TABLE 2-2 — MEMORY ACCESS DELAY TIMES

CONDITION	MODE	VDP DELAY	TIME WAITING FOR AN ACCESS WINDOW	TOTAL TIME
Active Display Area	Text	2 μ s	0 - 1.1 μ s	2 - 3.1 μ s
Active Display Area	Graphics I, II	2 μ s	0 - 5.95 μ s	2 - 8 μ s
4300 μ s after Vertical Interrupt Signal	All	2 μ s	0 μ s	2 μ s
Register 1 Blank Bit 0	All	2 μ s	0 μ s	2 μ s
Active Display Area	Multicolor	2 μ s	0 - 1.5 μ s	2 - 3.5 μ s

2.1.6 VDP Interrupt

The VDP INT output pin is used to generate an interrupt at the end of each active-display scan, which is about every 1/60 second for the TMS9918A/9928A and 1/50 second for the TMS9929A. The INT output is active when the Interrupt Enable bit (IE) in VDP Register 1 is a 1 and the F bit of the status register is a 1. Interrupts are cleared when the status register is read.

2.1.7 VDP Initialization

The VDP is externally initialized whenever the RESET input is active (low) and must be held low for a minimum of 3 microseconds. The external reset synchronizes all clocks with its falling edge, sets the horizontal and vertical counters to known states, and clears VDP registers 0 and 1. The video display is automatically blanked since the BLANK bit in VDP register 1 becomes a 0. The VDP, however, continues to refresh the VRAM even though the display is blanked. While the RESET line is active, the VDP does not refresh the VRAM.

2.2 WRITE-ONLY REGISTERS

The eight VDP write-only registers are shown in Figure 2-3. They are loaded by the CPU as described in Section 2.1.2. Registers 0 and 1 contain flags to enable or disable various VDP features and modes. Registers 2 through 6 contain values that specify starting locations of various sub-blocks of VRAM. The definitions of these sub-blocks are described in Section 2.4. Register 7 is used to define backdrop and text colors.

Each register is described in the following paragraphs.

2.2.1 Register 0

Register 0 contains two VDP option control bits. All other bits are reserved for future use and must be 0s.

BIT 6 M3 (mode bit 3) (see Section 2.3.2 for table and description)

BIT 7 External VDP enable/disable

0 disables external VDP input

1 enables external VDP input

NOTE

Enabling bit 7 in the TMS9928A/9929A causes A-Y and B-Y to go to the sync level only when all planes in front of the pixel under question are transparent.

2.2.2 Register 1 (contains 8 VDP option control bits)

BIT 0 4/16K selection

0 selects 4027 RAM operation

1 selects 4108/4116 RAM operation

BIT 1 BLANK enable/disable

0 causes the active display area to blank

1 enables the active display

Blanking causes the display to show border color only

BIT 2 IE (Interrupt Enable)

0 disables VDP interrupt

1 enables VDP interrupt

BIT 3,4 M1, M2 (mode bits 1 and 2)

M1, M2 and M3 determine the operating mode of the VDP:

M1	M2	M3	
0	0	0	Graphics I mode
0	0	1	Graphics II mode
0	1	0	Multicolor Mode
1	0	0	Text mode

BIT 5 Reserved

- BIT 6 Size (sprite size select)
 0 selects Size 0 sprites (8 × 8 bit)
 1 selects Size 1 sprites (16 × 16 bits)
- BIT 7 MAG (Magnification option for sprites)
 0 selects MAG0 sprites (1X)
 1 selects MAG1 sprites (2X)

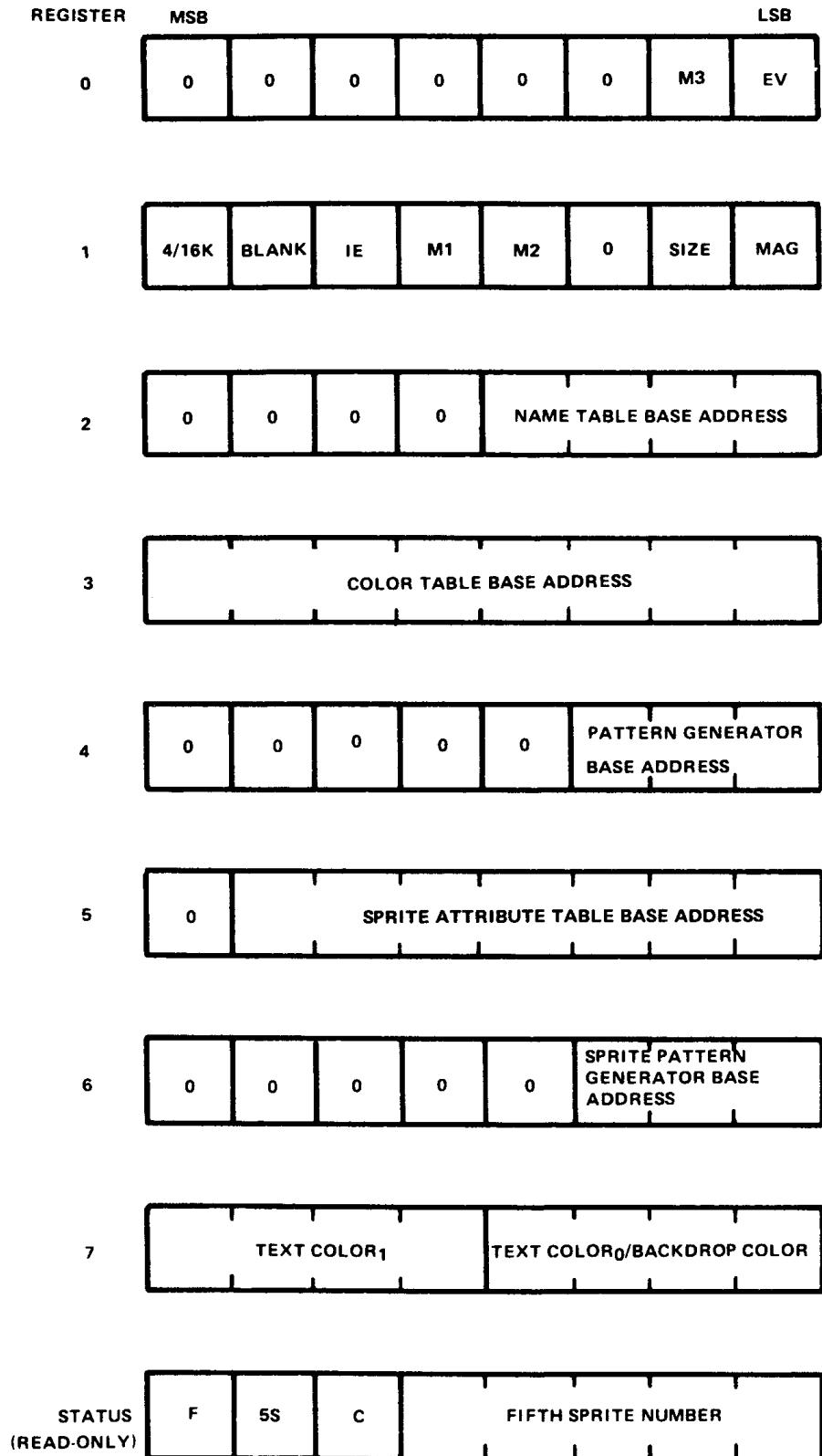

FIGURE 2-3 – VDP REGISTERS

2.2.3 Register 2

Register 2 defines the base address of the Name Table sub-block. The range of its contents is from 0 to 15. The contents of the register form the upper 4 bits of the 14-bit Name Table addresses; thus the Name Table base address is equal to (Register 2) *400(hex).

2.2.4 Register 3

Register 3 defines the base address of the Color Table sub-block. The range of its contents is from 0 to 255. The contents of the register form the upper 8 bits of the 14-bit Color Table addresses; thus the Color Table base address is equal to (Register 3) *40(hex).

2.2.5 Register 4

Register 4 defines the base address of the Pattern, Text or Multicolor Generator sub-block. The range of its contents is 0 through 7. The contents of the register form the upper 3 bits of the 14-bit Generator addresses; thus the Generator base address is equal to (Register 4) *800(hex).

2.2.6 Register 5

Register 5 defines the base address of the Sprite Attribute Table sub-block. The range of its contents is from 0 through 127. The contents of the register form the upper 7 bits of the 14-bit Sprite Attribute Table addresses; thus the base address is equal to (Register 5) *80(hex).

2.2.7 Register 6

Register 6 defines the base address of the Sprite Pattern Generator sub-block. The range of its contents is 0 through 7. The contents of the register form the upper 3 bits of the 14-bit Sprite Pattern Generator addresses; thus the Sprite Pattern Generator base address is equal to (Register 6) *800(hex).

2.2.8 Register 7

The upper 4 bits of Register 7 contain the color code of color 1 in the Text mode. The lower 4 bits contain the color code for color 0 in the Text mode and the backdrop color in all modes.

2.2.9 Setup Values for VDP Registers 2 through 6.

VRAM TABLE ADDRESSING

Register 2 in the VDP contains the starting address for the Name Table sub-block.

$$R2 * 400_{(16)} = \text{START ADDRESS}$$

R2	ADDRESS
00	0000
01	0400
02	0800
03	0C00 – MAXIMUM NUMBER FOR 4K RAMS
04	1000
05	1400
06	1800
07	1C00
08	2000
09	2400
0A	2800
0B	2C00
0C	3000
0D	3400
0E	3800
0F	3C00 – MAXIMUM NUMBER

Register 3 in the VDP contains the starting address for the Color Table.

(R3) * 40(16) STARTING ADDRESS

R3	START ADDRESS	R3	START ADDRESS	R3	START ADDRESS
00	0000	28	0A00	50	1400
01	0040	29	0A40	51	1440
02	0080	2A	0A80	52	1480
03	00C0	2B	0AC0	53	14C0
04	0100	2C	0B00	54	1500
05	0140	2D	0B40	55	1540
06	0180	2E	0B80	56	1580
07	01C0	2F	0BC0	57	15C0
08	0200	30	0C00	58	1600
09	0240	31	0C40	59	1640
0A	0280	32	0C80	5A	1680
0B	02C0	33	0CC0	5B	16C0
0C	0300	34	0D00	5C	1700
0D	0340	35	0D40	5D	1740
0E	0380	36	0D80	5E	1780
0F	03C0	37	0DC0	5F	17C0
10	0400	38	0E00	60	1800
11	0440	39	0E40	61	1840
12	0480	3A	0E80	62	1880
13	04C0	3B	0EC0	63	18C0
14	0500	3C	0F00	64	1900
15	0540	3D	0F40	65	1940
16	0580	3E	0F80	66	1980
17	05C0	3F	0FC0*	67	19C0
18	0600	40	1000	68	1A00
19	0640	41	1040	69	1A40
1A	0680	42	1080	6A	1A80
1B	06C0	43	10C0	6B	1AC0
1C	0700	44	1100	6C	1B00
1D	0740	45	1140	6D	1B40
1E	0780	46	1180	6E	1B80
1F	07C0	47	11C0	6F	1BC0
20	0800	48	1200	70	1C00
21	0840	49	1240	71	1C40
22	0880	4A	1280	72	1C80
23	08C0	4B	12C0	73	1CC0
24	0900	4C	1300	74	1D00
25	0940	4D	1340	75	1D40
26	0980	4E	1380	76	1D80
27	09C0	4F	13C0	77	1DC0

*Maximum number for 4K RAMS

(R3)* 40(16) STARTING ADDRESS (Concluded)

R3	START ADDRESS	R3	START ADDRESS	R3	START ADDRESS
78	1E00	A6	2980	D3	34C0
79	1E40	A7	29C0	D4	3500
7A	1E80	A8	2A00	D5	3540
7B	1EC0	A9	2A40	D6	3580
7C	1F00	AA	2A80	D7	35C0
7D	1F40	AB	2AC0	D8	3600
7E	1F80	AC	2B00	D9	3640
7F	1FC0	AD	2B40	DA	3680
80	2000	AE	2B80	DB	36C0
81	2040	AF	2BC0	DC	3700
82	2080	B0	2C00	DD	3740
83	20C0	B1	2C40	DE	3780
84	2100	B2	2C80	DF	37C0
85	2140	B3	2CC0	E0	2800
86	2180	B4	2D00	E1	3840
87	21C0	B5	2D40	E2	3880
88	2200	B6	2D80	E3	38C0
89	2240	B7	2DC0	E4	3900
8A	2280	B8	2E00	E5	3940
8B	22C0	B9	2E40	E6	3980
8C	2300	BA	2E80	E7	39C0
8D	2340	BB	2EC0	E8	3A00
8E	2380	BC	2F00	E9	1A40
8F	23C0	BD	2F40	EA	3A80
90	2400	BE	2F80	EB	3AC0
91	2440	BF	2FC0	EC	3B00
92	2480	C0	3000	ED	3B40
93	24C0	C1	3040	EE	3B80
94	2500	C2	3080	EF	3BCD
95	2540	C3	30C0	F0	3C00
96	2580	C4	3100	F1	3C40
97	25C0	C5	3140	F2	3C80
98	2600	C6	3180	F3	3CC0
99	2640	C7	31C0	F4	2D00
9A	2680	C8	3200	F5	3D40
9B	26C0	C9	3240	F6	3D80
9C	2700	CA	3280	F7	3DC0
9D	2740	CB	32C0	F8	3E00
9E	2780	CC	3300	F9	3E40
9F	27C0	CD	3340	FA	3E80
A0	2800	CE	3380	FB	3EC0
A1	2840	CF	33C0	FC	3F00
A2	2880	D0	3400	FD	3F40
A3	28C0	D1	3440	FE	3F80
A4	2900	D2	3480	FF	3FC0
A5	2940				

Register 4 in the VDP contains the starting address for the Pattern Generator Sub-block.

$$(R4) * 800_{(16)} = \text{START ADDRESS}$$

R4	START ADDRESS
00	0000
01	0800 – Max # for 4K RAMS
02	1000
03	1800
04	2000
05	2800
06	3000
07	3800 – Max # for 16K RAMS

Register 5 in the VDP contains the starting address for the Sprite Attribute Table.

$$(R5) * 80_{(16)} = \text{START ADDRESS}$$

R5	START ADDRESS	R5	START ADDRESS	R5	START ADDRESS	R5	START ADDRESS
00	0000	21	1080	40	2000	60	3000
01	0080	22	1100	41	2080	61	3080
02	0400	23	1180	42	2100	62	3100
03	0180	24	1200	43	2180	63	3180
04	0200	25	1280	44	2200	64	3200
05	0280	26	1300	45	2280	65	3280
06	0300	27	1380	46	2300	66	3300
07	0380	28	1400	47	2380	67	3380
08	0400	29	1480	48	2400	68	3400
09	0480	2A	1500	49	2480	69	3480
0A	0500	2B	1580	4A	2500	6A	3500
0B	0580	2C	1600	4B	2580	6B	3580
0C	0600	2D	1680	4C	2600	6C	3600
0D	0680	2E	1700	4D	2680	6D	3680
0E	0700	2F	1780	4E	2700	6E	3700
0F	0780	30	1800	4F	2780	6F	3780
10	0800	31	1880	50	2800	70	3800
11	0880	32	1900	51	2880	71	3880
12	0900	33	1980	52	2900	72	3900
13	0980	34	1A00	53	2980	73	3980
14	0A00	35	1A80	54	2A00	74	3A00
15	0A80	36	1B00	55	2A80	75	3A80
16	0B00	37	1B80	56	2B00	76	3B00
17	0B80	38	1C00	57	2B80	77	3B80
18	0C00	39	1C80	58	2C00	78	3C00
19	0C80	3A	1D00	59	2C80	79	3C80
1A	0D00	3B	1D80	5A	2D00	7A	3D00
1B	0D80	3C	1E00	5B	2D80	7B	3D80
1C	0E00	3D	1E80	5C	2E00	7C	3E00
1D	0E80	3E	1F00	5D	2E80	7D	3E80
1E	0F00	3F	1F80	5E	2F00	7E	3F00
1F	0F80 *			5F	2F80	7F	3F80
20	1000						

*Maximum number for 4K RAMS

Register 6 contains the value for the starting address of the Sprite Pattern Generator sub-block.
 STARTING ADDRESS = R6 * <800

R6	START ADDRESS
00	0000
01	0800 — Max # for 4K DRAMS
02	1000
03	1800
04	2000
05	2800
06	3000
07	3800 — Max # for 16K RAMS

2.3 STATUS REGISTER

The VDP has a single 8-bit status register that can be accessed by the CPU. The status register contains the interrupt pending flag, the sprite coincidence flag, the fifth sprite flag, and the fifth sprite number, if one exists. The format of the status register is shown in Figure 2-3 and is discussed in the following paragraphs.

The status register may be read at any time to test the F, C, and 5S status bits. Reading the status register will clear the interrupt flag, F. However, asynchronous reads will cause the frame flag (F) bit to be reset and therefore missed. Consequently, the status register should be read only when the VDP interrupt is pending.

2.3.1 Interrupt Flag (F)

The F status flag in the status register is set to 1 at the end of the raster scan of the last line of the active display. It is reset to a 0 after the status register is read or when the VDP is externally reset. If the Interrupt Enable bit in VDP Register 1 is active (1), the VDP interrupt output (INT) will be active (low) whenever the F status flag is a 1.

Note that the status register needs to be read frame by frame in order to clear the interrupt and receive the new interrupt of the next frame.

2.3.2 Coincidence Flag (C)

The C status flag in the status register is set to a 1 if two or more sprites coincide. Coincidence occurs if any two sprites on the screen have one overlapping pixel. Transparent colored sprites, as well as those that are partially or completely off the screen, are also considered. Sprites beyond the Sprite Attribute Table terminator (D016) are not considered. The C flag is cleared to a 0 after the status register is read or the VDP is externally reset. The status register should be read immediately upon powerup to ensure that the coincidence flag is reset.

The VDP checks each pixel position for coincidence during the generation of the pixel regardless of where it is located on the screen. This occurs every 1/60th of a second for the TMS918A and TMS9928A and every 1/50th of a second for the TMS9929A. Thus, when moving sprites more than one pixel position during these intervals, it is possible for the sprites to have multiple pixels overlapping or even to have passed completely over one another when the VDP checks for coincidence.

2.3.3 Fifth Sprite Flag (5S) and Number

The 5S status flag in the status register is set to a 1 whenever there are five or more sprites on a horizontal line (lines 0 to 192) and the frame flag is equal to a 0. The 5S status flag is cleared to a 0 after the status register is read or the VDP is externally reset. The number of the fifth sprite is placed into the lower 5 bits of the status register when the 5S flag is set and is valid whenever the 5S flag is 1. The setting of the fifth sprite flag will not cause an interrupt.

2.4 VIDEO DISPLAY MODES

The VDP displays an image on the screen that can best be envisioned as a set of display planes sandwiched together. Figure 2-4 shows the definition of each of the planes. Objects on planes closest to the viewer have higher priority. In cases where two entities on two different planes are occupying the same spot on the screen, the entity on the higher priority plane will show at that point. For an entity on a specific plane to show through, all planes in front of that plane must be transparent at that point. The first 32 planes (Figure 2-5) each may contain a single sprite. The areas of the Sprite Planes, outside of the sprite itself, are transparent. Since the coordinates of the sprite are in terms of pixels, the sprite can be positioned and moved about very accurately. Sprites are available in three sizes: 8×8 pixels, 16×16 pixels, and 32×32 pixels.

Behind the Sprite Planes is the Pattern Plane. The Pattern Plane is used for textual and graphics images generated by the Text, Graphics I, Graphics II, or Multicolor modes. Behind the Pattern Plane is the backdrop, which is larger in area than the other planes so that it forms a border around the other planes. The last and lowest priority plane is the External VDP Plane. Its image is defined by the external VDP input pin which allows the TMS9918A to mix the external video signal internal to the chip.

This mixing must occur outside of the chip for the TMS9928A and TMS9929A. This is achieved through the color difference outputs swinging to a special level (sync level is shown in Figure 2-6) not used by the color difference signals in normal operation. This occurs when bit 7 of Register 0 is set high. External mixing circuitry is required to detect this change in the level of the color difference signals and then switch from the VDP signals to an external source's signals (see Figures 2-7 and 2-8).

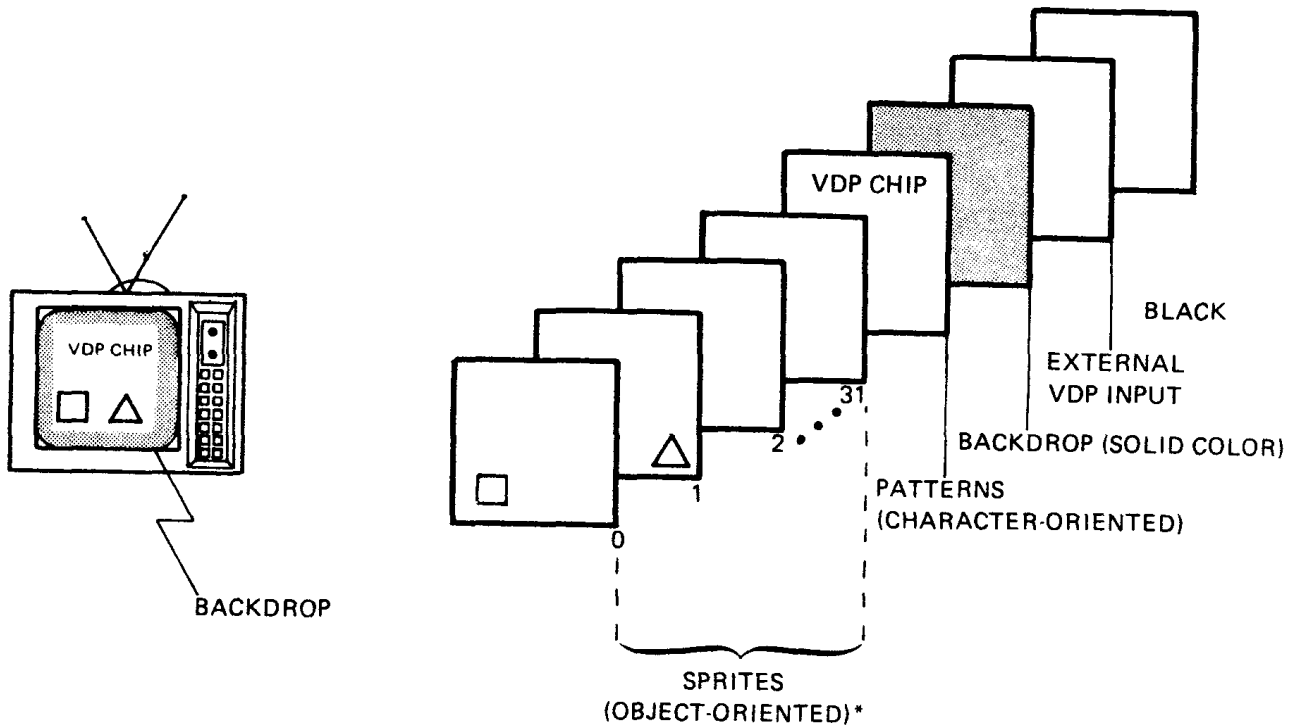

FIGURE 2-4 — VDP DISPLAY PLANES (DEFINITION)

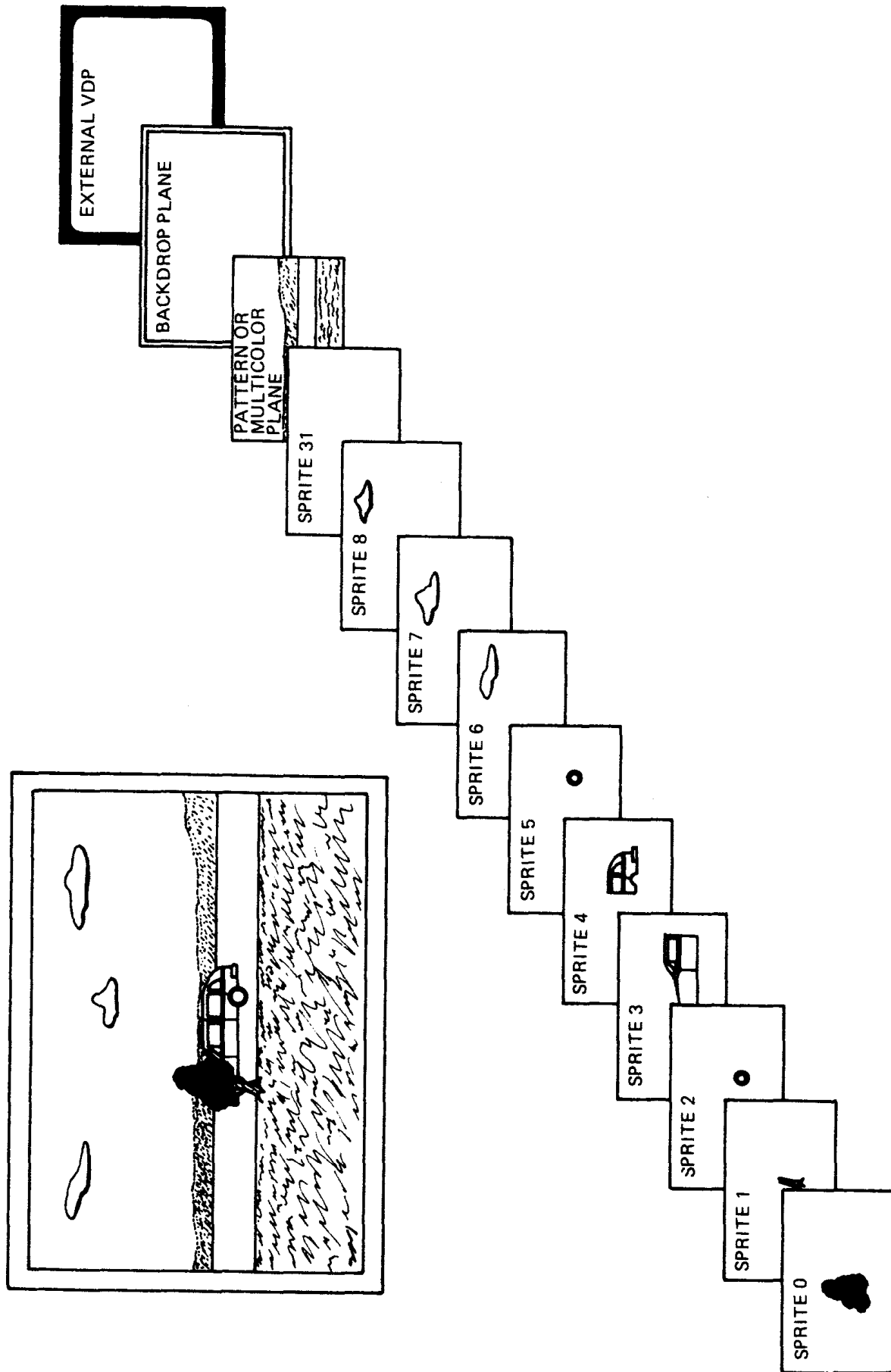

FIGURE 2-5 — VDP DISPLAY PLANES (FIRST 32 PLANES)

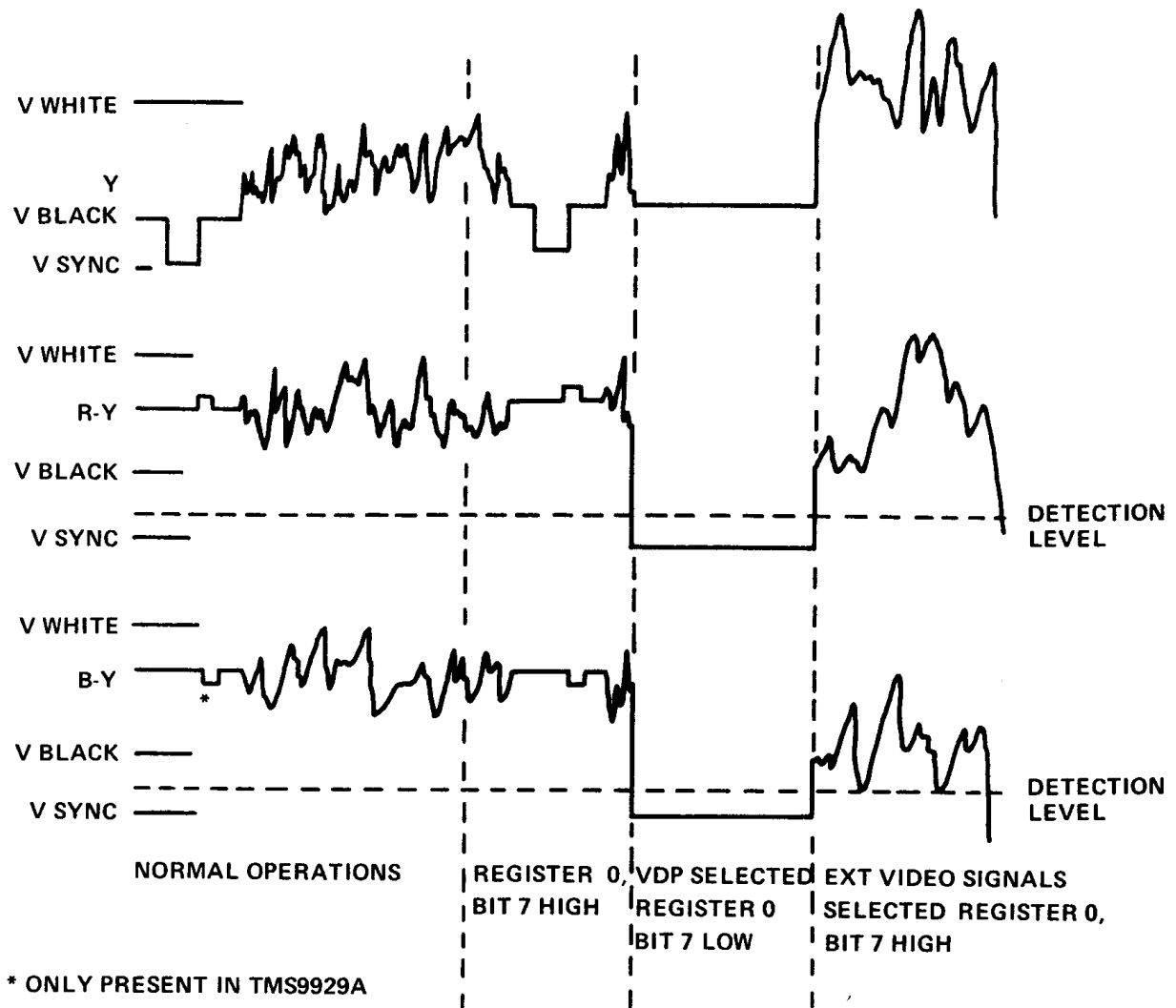

FIGURE 2-6 — TMS9928A/9929A SIGNAL WAVEFORMS FOR MULTIPLE VDP OPERATION

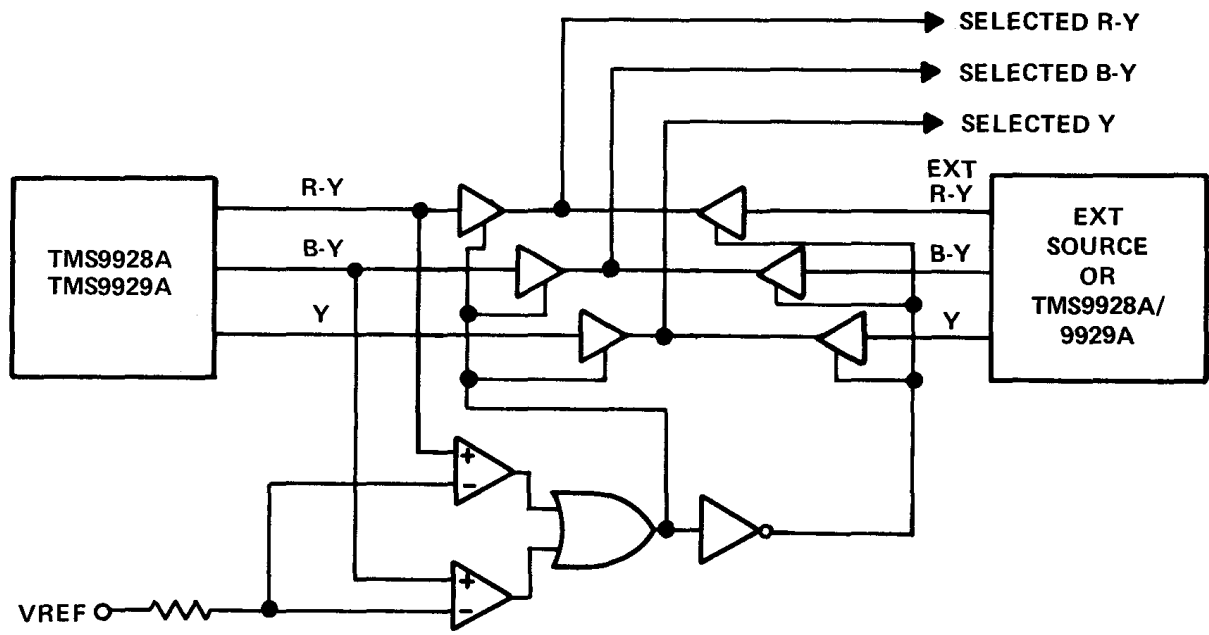

FIGURE 2-7 – USING COLOR DIFFERENCE SIGNALS TO MIX EXTERNAL COLOR DIFFERENCE TYPE SOURCE

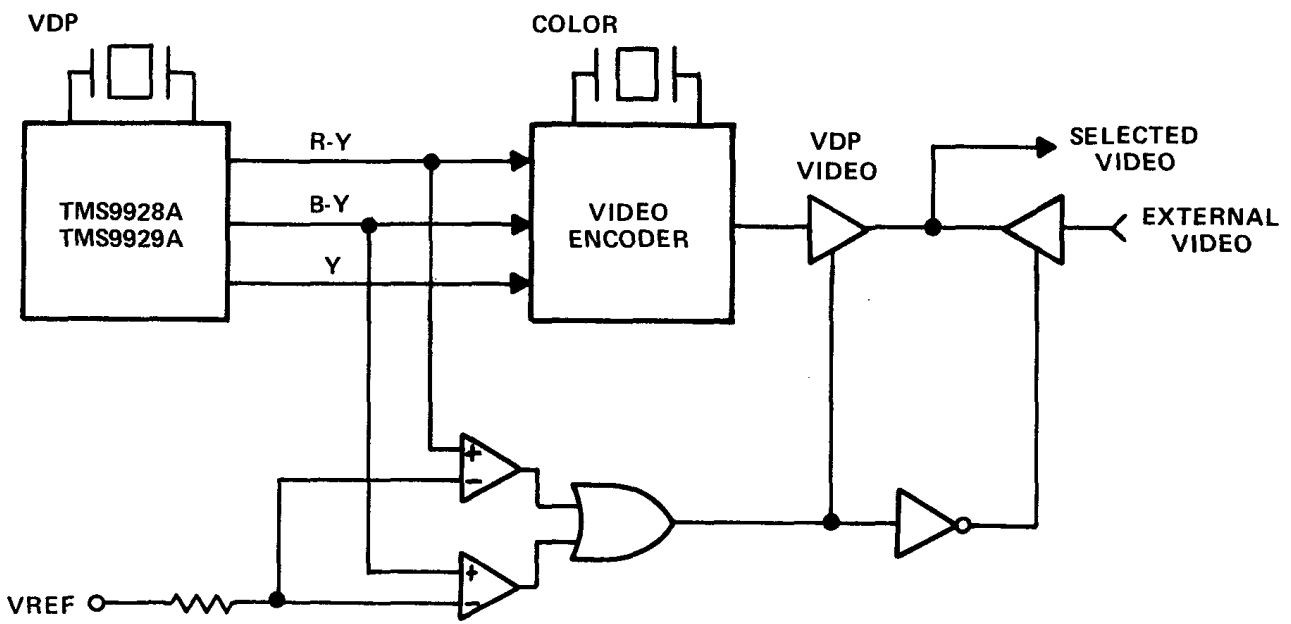

FIGURE 2-8 – USING COLOR DIFFERENCE SIGNALS TO MIX EXTERNAL VIDEO SOURCES

The backdrop consists of a single color used for the display borders and as the default color for the active display area. The default color is stored in the VDP Register 7. When the backdrop color register contains the transparent code, the backdrop automatically defaults to black if the external VDP mode is not selected.

The 32 Sprite Planes are used for the 32 sprites in the Multicolor and Graphics modes. They are not used in the Text mode and are automatically transparent. Each of the sprites can cover an 8×8 , 16×16 , or 32×32 pixel area on its plane. Any part of the plane not covered by the sprite is transparent. All or part of each sprite may also be transparent. Sprite 0 is on the outside or highest plane, and sprite 31 is on the plane immediately adjacent to Pattern Plane. Whenever a pixel in a Sprite Plane is transparent, the color of the next plane can be seen through that plane. If, however, the sprite pixel is non-transparent, the colors of the lower planes are automatically replaced by the sprite color.

There is also a restriction on the number of sprites on a line. Only four sprites can be active on any horizontal line. Additional sprites on a line will be automatically made transparent for that line. Only those sprites that are active on the display will cause the coincidence flag to set. The VDP status register provides a flag bit and the number of the fifth sprite whenever this occurs. The Pattern Plane is used in the Text, Multicolor, and Graphics modes for display of the graphic patterns of characters. Whenever a pixel on the Pattern Plane is nontransparent, the backdrop color is automatically replaced by the Pattern Plane color. When a pixel in the Pattern Plane is transparent, the backdrop color can be seen through the Pattern Plane.

The VDP has four video color display modes that appear on the Pattern Plane: Graphics I mode, Graphics II mode, Text mode, and Multicolor mode. Graphics I and Graphics II modes cause the Pattern Plane to be broken up into groups of 8×8 pixels, called pattern positions. Since the full image is 256×192 pixels, there are 32×24 pattern positions on the screen in the Graphics modes.

In Graphics I mode, 256 possible patterns may be defined for the 768 pattern positions with two unique colors allowed for each line of a pattern definition. Thus, all 15 colors plus transparent may be used in a single pattern position.

In Text mode, the Pattern Plane is broken into groups of 6×8 pixels, called text positions. There are 40×24 text positions on the screen in this mode. In Text mode, sprites do not appear on the screen and two colors are defined for the entire screen by VDP Register 7.

In Multicolor mode, the screen is broken into a grid of 64×48 positions, each of which is a 4×4 pixel. Within each position, one unique color is allowed.

The VDP registers define the base addresses for several sub-blocks within VRAM. These sub-blocks form tables which are used to produce the desired image on the TV screen. The Sprite Pattern Generator Table and the Sprite Attribute Table are used to form sprites. The contents of these tables must all be provided by the microprocessor. Animation is achieved by altering the contents of VRAM in real time.

The VDP can display the 15 colors shown in Table 2-3. The VDP colors also provide eight different gray levels for displays on monochrome television; the luminance value in the table indicates these levels, 0.00 being black and 1.00 being white. All other values in the table are expressed as percentages of the white/black voltage swing.

NOTE

The gray levels differ slightly for the TMS9918A when compared to the TMS9928A/9929A.

Whenever all planes are of the transparent color at a given point, and external video is not selected, the color shown at that point will be black.

TABLE 2-3 -- COLOR ASSIGNMENTS

COLOR HEX	COLOR	TMS9918A		TMS9928A/9929A		
		LUMINANCE (DC) VALUE	CHROMINANCE (AC VALUE)	Y	COLOR DIFFERENCE R-Y B-Y	
0	TRANSPARENT	0.00	-	-	-	-
1	BLACK	0.00	-	0.00	.47	.47
2	MEDIUM GREEN	.53	.53	.53	.07	.20
3	LIGHT GREEN	.67	.40	.67	.17	.27
4	DARK BLUE	.40	.60	.40	.4	1.00
5	LIGHT BLUE	.53	.53	.53	.43	.93
6	DARK RED	.47	.47	.47	.83	.30
7	CYAN	.67	.60	.73	0.00	.70
8	MEDIUM RED	.53	.60	.53	.93	.27
9	LIGHT RED	.67	.60	.67	.93	.27
A	DARK YELLOW	.73	.47	.73	.57	.07
B	LIGHT YELLOW	.80	.33	.80	.57	.17
C	DARK GREEN	.46	.47	.47	.13	.23
D	MAGENTA	.53	.40	.53	.73	.67
E	GRAY	.80	-	.80	.47	.47
F	WHITE	1.00	-	1.00	.47	.47
-	BLACK LEVEL	0.00	-	0.00	.47	.47
-	COLOR BURST	0.00	.40	0.00	47(28A) 73(29A)	.1(28A) .2(29A)
-	SYNC LEVEL	-0.40	-	-.46	.47	.47
-	EXTERNAL VIDEO LEVEL	-	-	0.00	.47	.47
-		-	-	0.00	-.46	-.46

2.4.1 Graphics I Mode

The VDP is in Graphics I mode when M1, M2, and M3 bits in VDP registers 1 and 0 are zero. When in this mode the Pattern Plane is divided into a grid of 32 columns by 24 rows of pattern positions as shown in Figure 2-9). Each of the pattern positions contains 8 × 8 pixel. The tables in VRAM used to generate the Pattern Plane are the Pattern Generator, Name, and Color Tables which require 2848 VRAM bytes. Figure 2-9 illustrates the mapping of these tables into the Pattern Plane. Less memory is required if all 256 possible pattern definitions are not required. The tables can be overlapped to reduce the amount of VRAM needed for pattern generation. Examples of VRAM memory allocation are provided in Section 3.3.

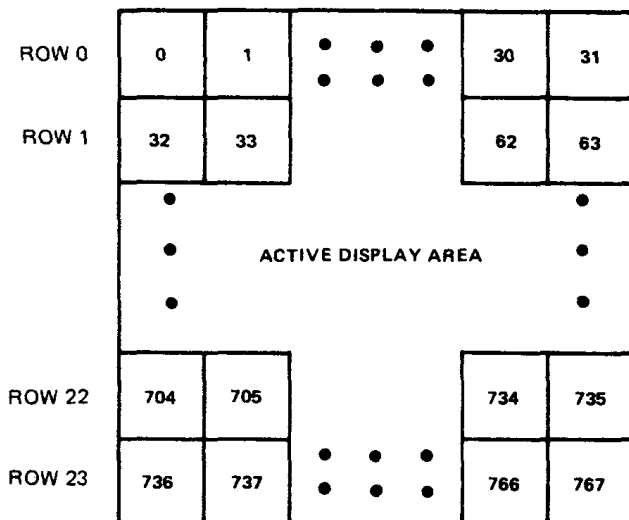

FIGURE 2-9 -- PATTERN GRAPHICS NAME TABLE MAPPING

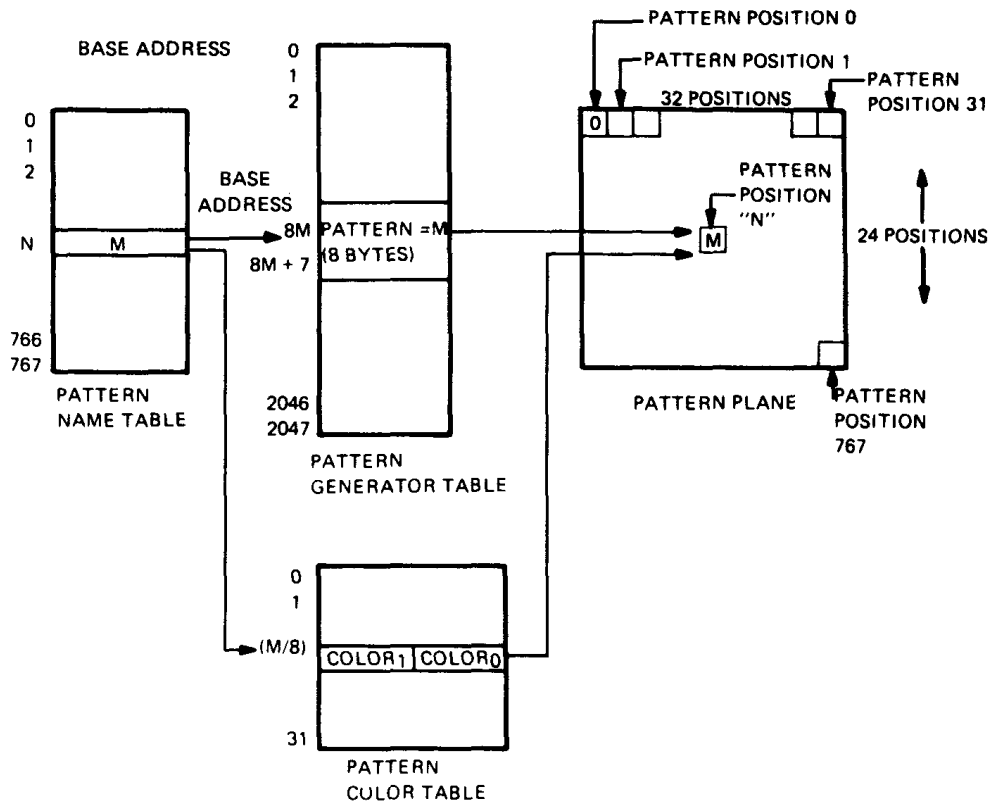

FIGURE 2-10 — GRAPHICS I MODE MAPPING

The Pattern Generator Table contains a library of patterns that can be displayed in the pattern positions. It is 2048 bytes long and is arranged into 256 patterns, each of which is 8 bytes long, yielding 8×8 bits. All of the 1s in the 8-byte pattern can designate one color (color 1), while all the 0s can designate another color (color 0).

The full 8-bit pattern name is used to select one of the 256 pattern definitions in the Pattern Generator Table. The table is a 2048-byte block in VRAM beginning on a 2-kilobyte boundary. The starting address of the table is determined by the generator base address in VDP Register 4. The base address forms the three MSBs of the 14-bit VRAM address for each Pattern Generator Table entry. The next 8 bits indicate the 8-bit name of the selected pattern definition. The lowest 3 bits of the VRAM address indicate the row number within the pattern definition.

There are 8 bytes required for each of the 256 possible unique 8×8 pattern definitions. The first byte defines the first row of the pattern, and the second byte defines the second row. The first bit of each of the eight bytes defines the first column of the pattern. The remaining rows and columns are similarly defined. Each bit entry in the pattern definition selects one of the two colors for that pattern. A 1 bit selects the color code (color 1) contained in the most significant 4 bits of the corresponding color table byte. A 0 bit selects the other color code (color 0). An example of pattern definition mapping is provided in Figure 2-11.

ROW/BYTE	COLUMN (PATTERN)					BIT (PATTERN DEFINITION)								
	0	1	2	3	4	5	0	1	2	3	4	5	6	7
0		C	C	C	C	C	0	1	1	1	1	1	0	0
1						C	0	0	0	0	0	1	0	0
2						C	0	0	0	0	0	1	0	0
3			C	C	C	C	0	0	1	1	1	1	0	0
4						C	0	0	0	0	0	1	0	0
5						C	0	0	0	0	0	1	0	0
6		C	C	C	C	C	0	1	1	1	1	1	0	0
7						C	0	0	0	0	0	0	0	0

NOTES: VDP register 7 entry: 71_{16} .
 Color code 7 is cyan (signified above by 'C').
 Color code 1 is black (signified above by a space).
 Bit 0 is the most significant bit of each data byte.

FIGURE 2-11 — PATTERN DISPLAY MAPPING

The color of the 1s and 0s is defined by the Pattern Color Table that contains 32 entries, each of which is 1 byte long. Each entry defines two colors: the most significant 4 bits of each entry define the color of the 1s, and the least significant 4 bits define the color of the 0s. The first entry in the color table defines the colors for patterns 0 to 7; the next entry for patterns 8 to 15, and so on. (See Table 2-4 for assignments.) Thus, 32 different pairs of colors may be displayed simultaneously.

The Pattern Name Table is located in a contiguous 768-byte block in VRAM beginning on a 1-kilobyte boundary. The starting address of the Name Table is determined by the 4-bit Name Table base address field in VDP Register 2. The base address forms the upper 4 bits of the 14-bit VRAM address. The lower 10 bits of the VRAM address are formed from the row and column counters. An example of pattern name table addressing is given in Section 3.3.

TABLE 2-4 – GRAPHICS I MODE COLOR TABLE

Byte No.	Pattern No.	Byte No.	Pattern No.
0	0..7	16	128..135
1	8..15	17	136..143
2	16..23	18	144..151
3	24..31	19	152..159
4	32..39	20	160..167
5	40..47	21	168..175
6	48..55	22	176..183
7	56..63	23	184..191
8	64..71	24	192..199
9	72..79	25	200..207
10	80..87	26	208..215
11	88..95	27	216..223
12	96..103	28	224..231
13	104..111	29	232..239
14	112..119	30	240..247
15	120..127	31	248..255

Each byte entry in the Name Table is either the name of or the pointer to a pattern definition in the Pattern Generator Table. The upper 5 bits of the 8-bit name identify the color group of the pattern. There are 32 groups of 8 patterns. The same two colors are used for all eight patterns in a group; the color codes are stored in the VDP Color Table. The Color Table is located in a 32-byte block in VRAM beginning on a 64-byte boundary. The table starting address is determined by the 8-bit Color Table base address in VDP Register 3. The base address forms the upper 8 bits of the 14-bit Color Table entry VRAM address. The next bit is a 0 and the lowest 5 bits are equal to the upper 5 bits of the corresponding Name Table entries.

Since the tables in VRAM have their base addresses defined by the VDP registers, a complete switch of the values in the tables can be made by simply changing the values in the VDP registers. This is especially useful when one wishes to time-slice between two or more screens of graphics.

When the Pattern Generator Table is loaded with a pattern set, manipulation of the Pattern Name Table contents can change the appearance of the screen. Alternatively, a dynamically changing set of patterns throughout the course of a graphics session is easily accomplished since all tables are in VRAM. A total of 2848 VRAM bytes are required for the Pattern, Name, Color and Generator tables. Less memory is needed if all 256 possible pattern definitions are not required; the tables can be overlapped to reduce the amount of VRAM needed for pattern generation. Examples of VRAM memory allocation are provided in Section 3.3.

2.4.2 Graphics II Mode

The VDP is in the Graphics II mode bits ($M1 = 0$, $M2 = 0$ and $M3 = 1$). The Graphics II mode is similar to Graphics I mode except it allows a larger library of patterns so that a unique pattern generator entry may be made for each of the 768 (32×24) pattern positions on the video screen. Additionally, more color information is included in each 8×8 graphics pattern. Thus, two unique colors may be specified for each byte of the 8×8 pattern. A larger amount of VRAM (12 kilobytes) is required to implement the full usage of the Graphics II mode.

Like Graphics I mode, the Graphics II mode Pattern Name Table contains 768 entries which correspond to the 768 pattern positions on the display screen. Because the Graphics I mode pattern names are only 8 bits in length, a maximum of 256 pattern definitions may be addressed using the addressing scheme discussed in Section 2.4.10. Graphics II mode, however, segments the display screen into three equal parts of 256 pattern positions each and also segments the Pattern

Generator Table into three equal blocks of 2048 bytes each. Pattern definitions in the first third of the display screen correspond to pattern positions in the upper third. Likewise, pattern definitions in the second and third blocks of the Pattern Generator Table correspond to the second and third areas of the Pattern Plane.

The Pattern Name Table is also segmented into three blocks of 256 names each so that names found in the upper third reference pattern definitions are found in the upper 2048 bytes in Pattern Generator Table. Similarly, the second and third blocks reference pattern definitions in the second 2048-byte block and third-2048 byte block, respectively. Thus, if 768 patterns are uniquely specified, an 8-bit pattern name will be used three times, once in each segment of the Pattern Name Table. The Pattern Generator Table falls on 8-kilobyte boundaries and may be located in the upper or lower half of 16K memory based on the MSB of the pattern generator base in VDP Register 4. The LSBs must be set to all 1s.

The Color Table is also 6144 bytes long and is segmented into three equal blocks of 2048 bytes. Each entry in the Pattern Color Table is 8 bytes which provides the capability to uniquely specify color 1 and color 0 for each of the 8 bytes of the corresponding pattern definition. The addressing scheme is exactly like that of the Pattern Generator Table except for the location of the table in VRAM. This is controlled by the loading of the MSB of the color base in VDP Register 3. The LSBs must be set to all 1s.

Figure 2-12 illustrates the Graphics II mode mapping scheme. Note that pattern names, P1, P2, and P3, correspond to pattern generator entries in the three blocks of the Pattern Generator Table. Note also how these three names map to the display screen. Figure 2-13 is an example of a Pattern Generator and Pattern Color Table entry.

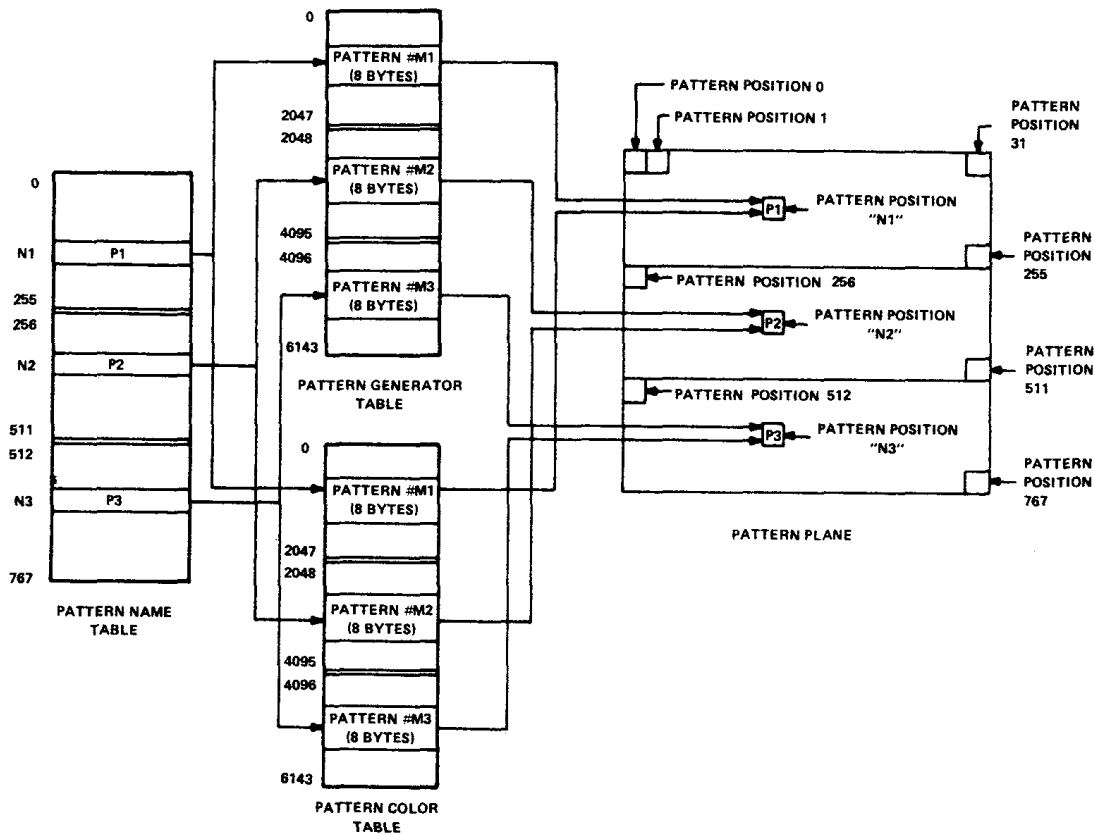

FIGURE 2-12 — GRAPHICS II MODE MAPPING

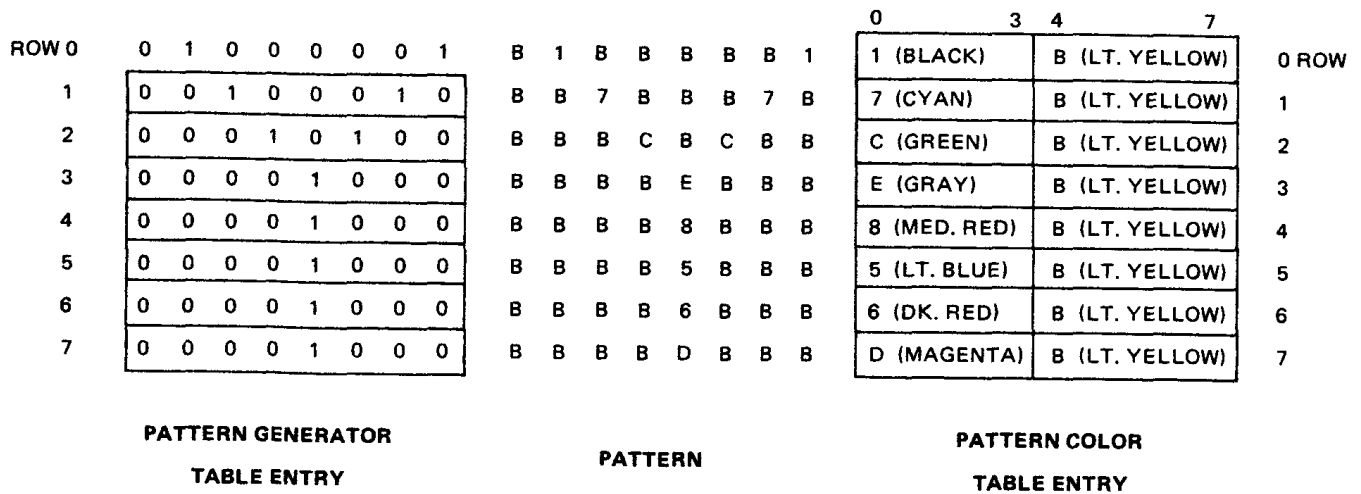

FIGURE 2-13 — PATTERN DISPLAY MAPPING

2.4.3 Multicolor Mode

The VDP is in Multicolor mode when mode bits M1 = 0, M2 = 1, and M3 = 0. Multicolor mode provides an unrestricted 64 × 48 color square display. Each color square contains a 4 × 4 block of pixels. The color of each of the color squares can be any one of the 15 video display colors plus transparent. Consequently, all 15 colors can be used simultaneously in the Multicolor mode. The Backdrop and Sprite Planes are still active in the Multicolor mode.

The Multicolor Name Table is the same as that for the graphics modes, consisting of 768 name entries, although the name no longer points to a color list. Color is now derived from the Pattern Generator Table. The name points to an 8-byte segment of VRAM in the Pattern Generator Table.

Only 2 bytes of the 8-byte segment are used to specify the screen image. These 2 bytes specify four colors, each color occupying a 4 × 4-pixel area. The 4 MSBs of the first byte define the color of the upper left quarter of the multicolor pattern; the LSBs define the color of the upper right quarter. The second byte similarly defines the lower left and right quarters of the multicolor pattern. The 2 bytes thus map into an 8 × 8-pixel multicolor pattern. (See Figure 2-14).

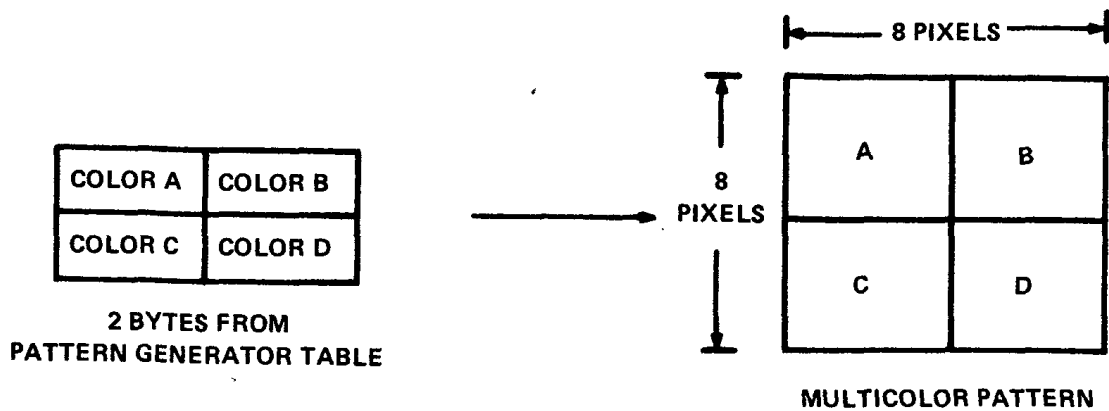

FIGURE 2-14 — MULTICOLOR LIST MAPPING

The location of the 2 bytes within the 8-byte segment pointed to by the name is dependent upon the screen position where the name is mapped. For names in the top row (names 0-31), the 2 bytes are the first two within the groups of 8-byte segments pointed to by the names. The next row of names (32-63) uses the bytes 3 and 4 within the 8-byte segments. The next row of names uses bytes 5 and 6 while the last row of names uses bytes 7 and 8. This series repeats for the remainder of the screen.

For example, referring to Figure 2-15 if Name Table entry 0 (pattern position 0) multicolor block #N (name = N), the multicolor pattern displayed will be an 8 × 8-pixel block consisting of colors A, B, C, and D which comprise the first two bytes of the Multicolor Table. If, however, name #N is located in Name Table entry 33, (Pattern position 33), the colors displayed will be colors E, F, G, and H as specified by bytes 3 and 4 of the multicolor block pointed to by the name.

Likewise, pattern positions which lie in rows 2 and 3 would cause colors I, J, K, L and colors M, N, O, P, respectively, to be displayed. Thus, it can be seen that the color displayed from the multicolor generator block is dependent upon pattern position on the screen. Figure 2-16 illustrates the Multicolor mode mapping scheme.

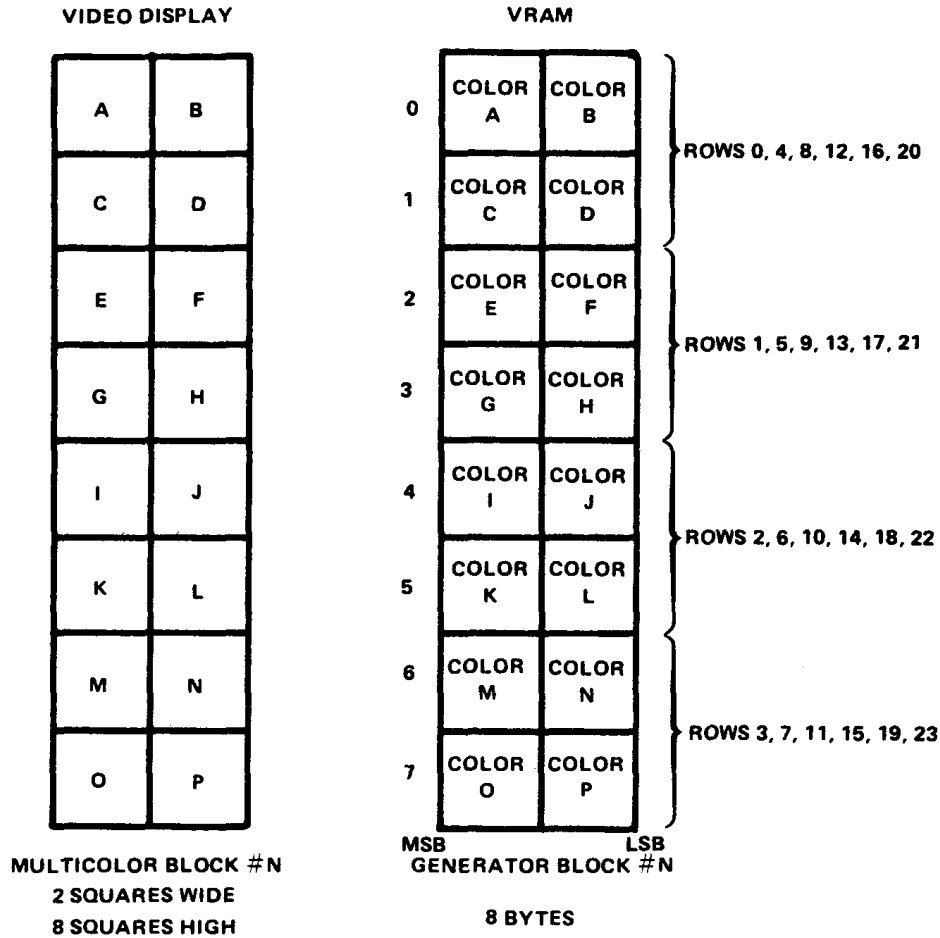

FIGURE 2-15 — MULTICOLOR BLOCK DISPLAY

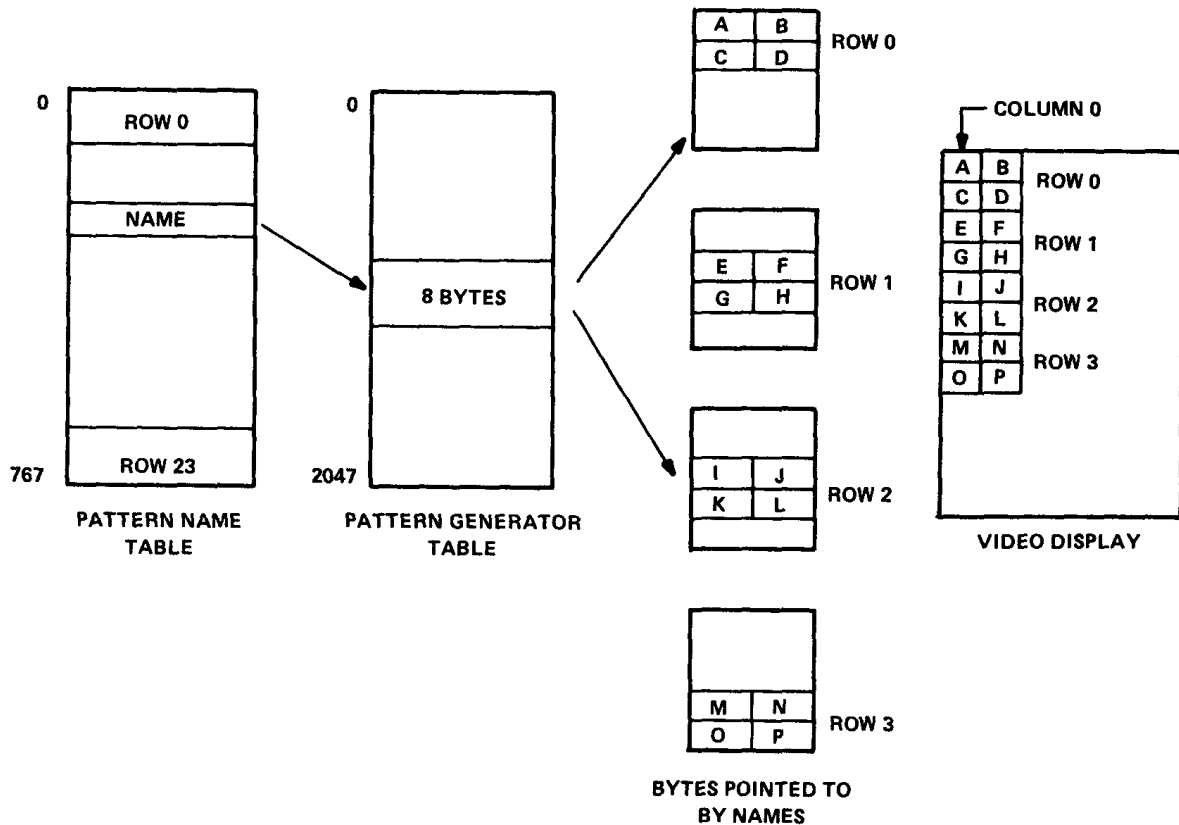

FIGURE 2-16 – MULTICOLOR MODE MAPPING

The mapping of VRAM contents to screen image is simplified by using duplicate names in the Name Table since the series of bytes used within the 8-byte segment specifies a 2×8 color square pattern on the screen as a straightforward translation from the 8-byte segment in VRAM pointed to by the common name.

When used in this manner, 768 bytes are still used for the Name Table and 1536 bytes are used for the color information in the Pattern Generator Table (24 rows \times 32 columns \times 8 bytes/pattern position). Thus, a total of 1728 bytes in VRAM are required. It should be noted that the tables begin on even 1K and 2K boundaries and are therefore not contiguous. An example of multicolor VRAM memory allocation is given in Section 3.3.

2.4.4 Text Mode

The VDP is in Text mode when mode bits M1 = 1, M2 = 0, and M3 = 0. In this mode, the screen is divided into a grid of 40 text positions across and 24 down. (See Figure 2-17). Each of the text positions contains 6 pixels across and 8 pixels down. The tables used to generate the Pattern Plane are the Pattern Name Table and the Pattern Generator Table. There can be up to 256 unique patterns defined at any time. The pattern definitions are stored in the Pattern Generator Table in VRAM and can be dynamically changed. The VRAM contains a Pattern Name Table which maps the pattern definition into each of the 960 pattern cells on the Pattern Plane (Figure 2-18). Sprites are not available in Text mode.

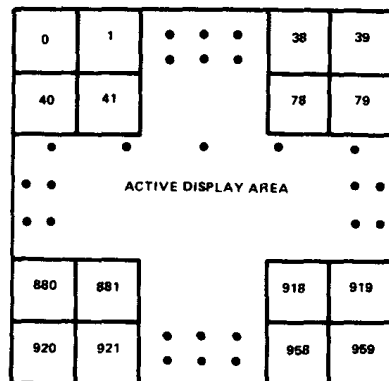

FIGURE 2-17 – TEXT MODE NAME TABLE PATTERN POSITIONS

As with the Graphics modes, the Pattern Generator Table contains a library of text patterns that can be displayed in the text positions. It is 2048 bytes long and is arranged in 256 text patterns, each of which is 8 bytes long. Since each text position on the screen is only 6 pixels across, the least significant 2 bits of each text pattern are ignored, yielding 6×8 bits in each text pattern. Each 8-byte block defines a text pattern in which all the 1s in the text pattern take on one color when displayed on the screen, while all the 0s take on another color. These colors are chosen by loading VDP Register 7 with the color 1 and color 0 in the left and right nibbles, respectively (see Section 2.2).

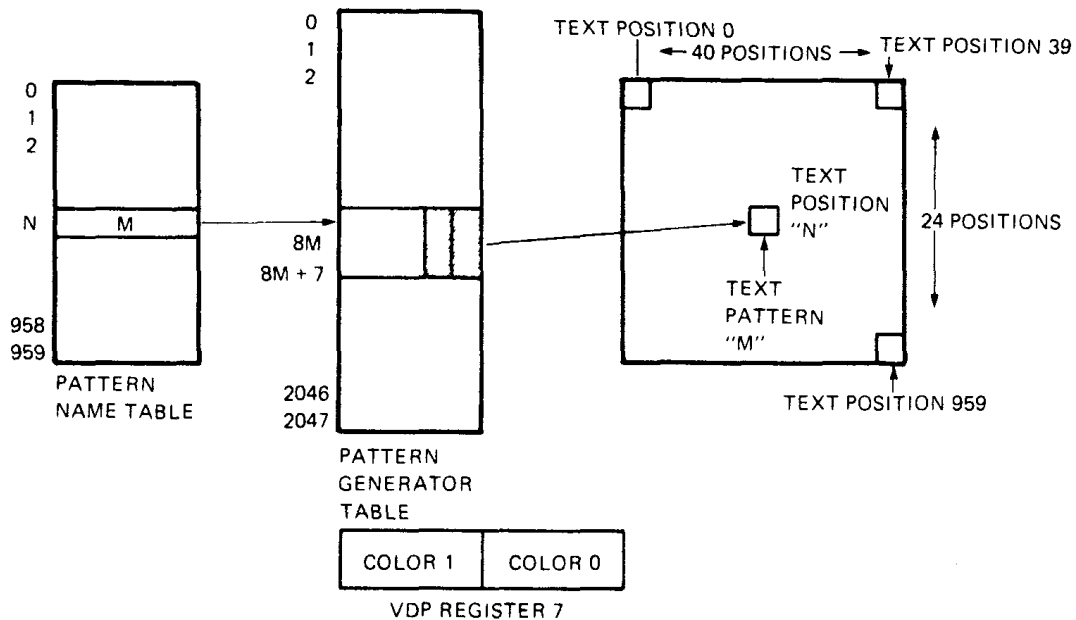

FIGURE 2-18 — MAPPING OF VRAM INTO THE PATTERN PLANE IN TEXT MODE

In the Text mode, the Pattern Name Table determines the position of the text pattern on the screen as shown in Figure 2-18. There are 960 entries in the Pattern Name Table, each 1 byte long. There is a one-to-one correspondence between text pattern positions on the screen and entries in the Pattern Name Table ($40 \times 24 = 960$). The first 40 entries correspond to the top row of text pattern positions on the screen, the next 40 to the second row, and so on. The value of an entry in the Pattern Name Table indicates which of the 256 text patterns is to be placed at that spot on the Pattern plane.

The Pattern Name Table is located in a contiguous 960-byte block in VRAM, beginning on a 1-kilobyte boundary. The starting address of the name table is determined by the 4-bit name table base address field in VDP Register 2. The base address forms the upper 4 bits of the 14-bit VRAM address. The lower 10 bits of the VRAM address point to 1 of 960 pattern cells. The name table is organized by rows. An example of Pattern Name Table addressing is given in Section 4.

Each byte entry in the name table is the pointer to a pattern definition in the Pattern Generator Table. The same two colors are used for all 256 patterns; the color codes are stored in VDP Register 7.

As the name implies, the Text mode is intended mainly for textual applications, especially those in which the 32 patterns-per-line in Graphics modes is insufficient. The advantage is that eight more patterns can be fitted onto one line; the disadvantages are that sprites cannot be used, and only two colors are available for the entire screen.

With care, the same text pattern set that is used in Text mode can be also used in Graphics I mode. This is done by ensuring that the least significant 2 bits of all the character patterns are 0. Thus, a switch from Text mode to Pattern mode results in a stretching of the space between characters, and a reduction of the number of characters per line from 40 to 32. As with the Graphics Modes, once a character set has been defined and placed into the Pattern Generator, updating the Pattern Name Table will produce and manipulate textual material on the screen.

The full 8-bit pattern name is used to select 1 of the 256 pattern definitions in the pattern generator table. The table is a 2048-byte block in VRAM, beginning on a 2-kilobyte boundary. The starting address of the table is determined by the generator base address in VDP Register 4. The base address forms the 3 MSBs of the 14-bit VRAM address for each Pattern Generator Table entry. The next 8 bits are equal to the 8-bit name of the selected pattern definition. The lowest 3 bits of the VRAM address are equal to the row number within the pattern definition.

There are 8 bytes required for each of the 256 possible unique 6×8 pattern definitions. The first byte defines the first row of the pattern, and the second byte defines the second row. The least significant 2 bits in each byte are not used. However, it is strongly recommended that these bits be 0s. Each bit entry in the pattern definition selects one of the two colors for

that pattern. A 1 bit selects the color code (color 1) contained in the most significant 4 bits of VDP Register 7. A 0 bit selects the other color code (color 0) which is in the least significant 4 bits of the same VDP Register. Figure 2-18 is an example of pattern definition mapping.

A total of 3008 VRAM bytes are required for the Pattern Name Generator Tables. Less memory is required if all 256 possible pattern definitions are not required; the tables can be overlapped to reduce the amount of VRAM needed for pattern generation. Examples of VRAM memory allocation are provided in Section 3.3.

2.4.5 Sprites

The video display can have up to 32 sprites on the highest priority video planes. The sprites are special animation patterns which provide smooth motion and multilevel pattern overlaying. The location of a sprite is defined by the top left-hand corner of the sprite pattern. The sprite can be easily moved pixel-by-pixel by redefining the sprite origin. This provides a simple but powerful method of quickly and smoothly moving special patterns. The sprites are not active in the Text mode. The 32 Sprite Planes are fully transparent outside of the sprite itself.

The sub-blocks in VRAM that define sprites are the Sprite Attribute Table (see Figure 2-19) and the Sprite Generator Table (see Section 4.4). These tables are similar to their equivalents in the pattern realm in that the Sprite Attribute Table specifies where the sprite goes on the screen, while the Sprite Generator Table describes what the sprite looks like. Sprite Pattern formats are given in Table 2-5.

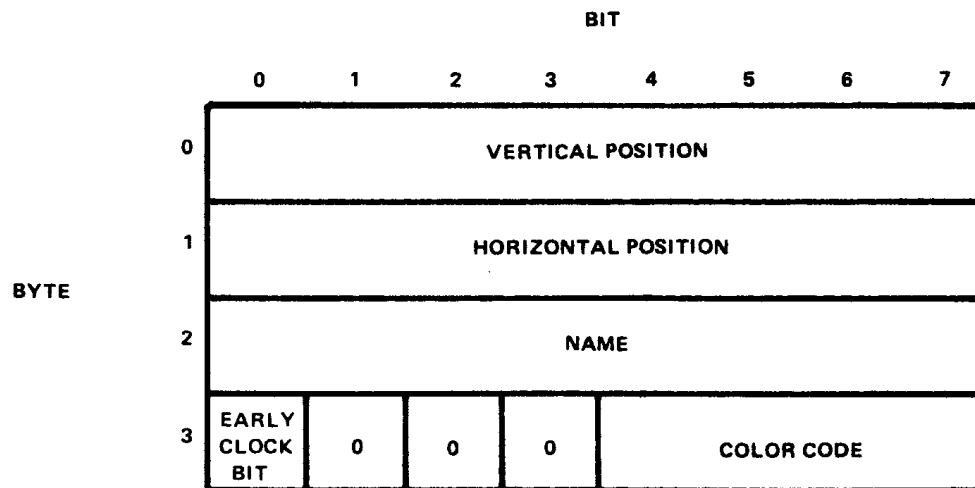

FIGURE 2-19 — SPRITE ATTRIBUTE TABLE ENTRY

TABLE 2-5 — SPRITE PATTERN FORMATS

SIZE	MAG	AREA	RESOLUTION	BYTES/PATTERN
0	0	8 × 8	single pixel	8
1	0	16 × 16	single pixel	32
0	1	16 × 16	2 × 2 pixels	8
1	1	32 × 32	2 × 2 pixels	32

Figure 2-20 illustrates the manner in which the VRAM tables map into the existence of sprites on the display. Since there are 32 sprites available for display, there are 32 entries in the Sprite Attribute Table. Each entry consists of four bytes. The entries are ordered so that the first entry corresponds to the sprite on the sprite 0 plane, the next to the sprite on the sprite 1 plane, and so on. The Sprite Attribute Table is $4 \times 32 = 128$ and is located in a contiguous 128-byte block in VRAM, beginning on a 128-byte boundary.

The starting address of the table is determined by the 7-bit Sprite Attribute Table base address in VDP Register 5. The base address forms the upper 7 bits of the 14-bit VRAM address. The next 5 bits of the VRAM address are equal to the sprite number. The lowest 2 bits select 1 of the 4 bytes in Sprite 2 Attribute Table entry for each sprite. Each table entry contains 4 bytes which specify the sprite position, sprite pattern name, and color, as shown in Figure 2-19.

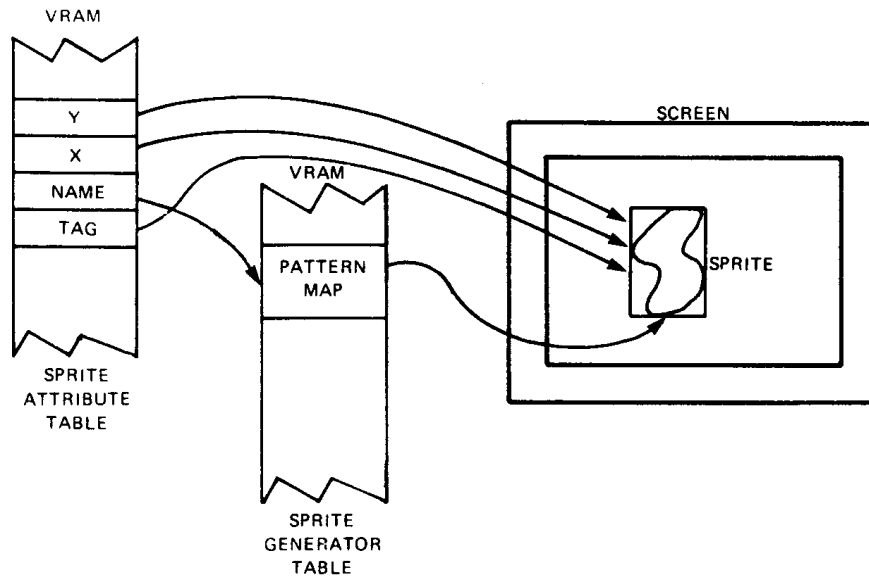

FIGURE 2-20 – SPRITE MAPPING

The first two bytes of each entry of the Sprite Attribute Table determine the position of the sprite on the display. The first byte indicates the vertical distance of the sprite from the top of the screen, in pixels. It is defined such that a value of -1 puts the sprite butted up at the top of the screen, touching the backdrop area. The second byte describes the horizontal displacement of the sprite from the left edge of the display. A value of 0 butts the sprite up against the left edge of the backdrop. Note that all measurements are taken from the upper left pixel of the sprite.

When the first two bytes of an entry position a sprite so it overlaps backdrop, the part of the sprite that is within the backdrop is displayed normally. The part of the sprite that overlaps the backdrop is hidden from view by the backdrop. This allows the animator to move a sprite into display from behind the backdrop.

The displacement in the first byte is partially signed, in that values for vertical displacement between -31 and 0 ($E116$ to 0) allow a sprite to bleed-in from the top edge of the backdrop. Similarly, horizontal displacement values in the vicinity of 255 allow a sprite to bleed-in from the right side of the screen. To allow sprites to bleed-in from the left edge of the backdrop, a special bit in the third byte of the Sprite Attribute Table entry is used.

Byte 3 of the Sprite Attribute Table entry contains the pointer to the Sprite Generator Table that specifies what the sprite should look like. This is an 8-bit pointer to the sprite patterns definition, the Sprite Generator Table. The sprite name is similar to that in the Graphics Modes.

Byte 4 of the Sprite Attribute Table entry contains the color of the sprite in its lower 4 bits (see Table 2-3 for color assignments). The MSB is the Early Clock (EC) bit. When set to 0 , this bit does nothing. When set to 1 , the horizontal position of the sprite is shifted to the left by 32 pixels. This allows a sprite to bleed-in from the left edge of the backdrop. Values for horizontal displacement (byte 2 in the entry) in the range 0 to 32 cause the sprite to overlap with the left-hand border of the backdrop.

The Sprite Generator Table is a maximum of 2048 bytes long beginning on the 2-kilobyte boundaries. It is arranged into 256 blocks of 8 bytes each. The third byte of the Sprite Attribute Table entry, then specifies which 8-byte block to use to specify a sprite's shape. The 1s in the Sprite Generator cause the sprite to be defined at the point; 0s cause the transparent color to be used. The starting address of the table is determined by the sprite generator base address in VDP Register 6. The base address forms the 3 MSB of the 14-bit VRAM address. The next 8 bits of the address are equal to sprite name, and the last 3 bits are equal to the row number within the sprite pattern. The address formation is slightly modified for $SIZE_1$ sprites.

There is a maximum limit of four sprites that can be displayed on one horizontal line. If this rule is violated, the four highest-priority sprites on the line are displayed normally. The fifth and subsequent sprites are not displayed on that line. Furthermore, the fifth-sprite bit in the VDP status register is set to a 1 , and the number of the violating fifth sprite is loaded into the status register (see Section 2.3).

Larger sprites than 8×8 pixels can be used if desired. The MAG and SIZE bits in VDP register 1 are used to select the various options described in the following paragraphs.

- MAG=0,SIZE=0: No options chosen
- MAG=1,SIZE=0 The Sprite Generator Table uses 8 bytes to describe the sprite; however, each bit in the Sprite Generator maps into 2×2 pixels on the TV screen, effectively doubling the size of the sprite to 16×16 .
- MAG=0,SIZE=1: The Sprite Generator Table uses 31 bytes to define the sprite shape; the result is a 16×16 -pixel sprite. The mapping of the 32 bytes into the sprite image is as shown in Figure 2-21. Mapping is still 1 bit to 1 pixel.
- MAG=1,SIZE=1: Same as MAG = 0, SIZE = 1 except each bit now maps into a 2×2 -pixel area, yielding a 32×32 sprite.

The VDP provides sprite coincidence checking. The coincidence status flag in the VDP status register is set to a 1 whenever two active sprites have 1 bits at the same screen location.

Sprite processing is terminated if the VDP finds a value of 208 (D016) in the vertical position field of any entry in the Sprite Attribute Table. This permits the Sprite Attribute Table to be shortened to the minimum size required; it also permits the user to blank out part or all of the sprites by simply changing one byte in VRAM.

A total of 2176 VRAM bytes are required for the Sprite Name and Pattern Generator Tables. Significantly less memory is required if all 256 possible sprite pattern definitions are not required. The Sprite Attribute Table can also be shortened as described in the preceding paragraph. The tables can be overlapped to reduce the amount of VRAM required for sprite generation. Examples of VRAM memory allocation are provided in Section 3.3.

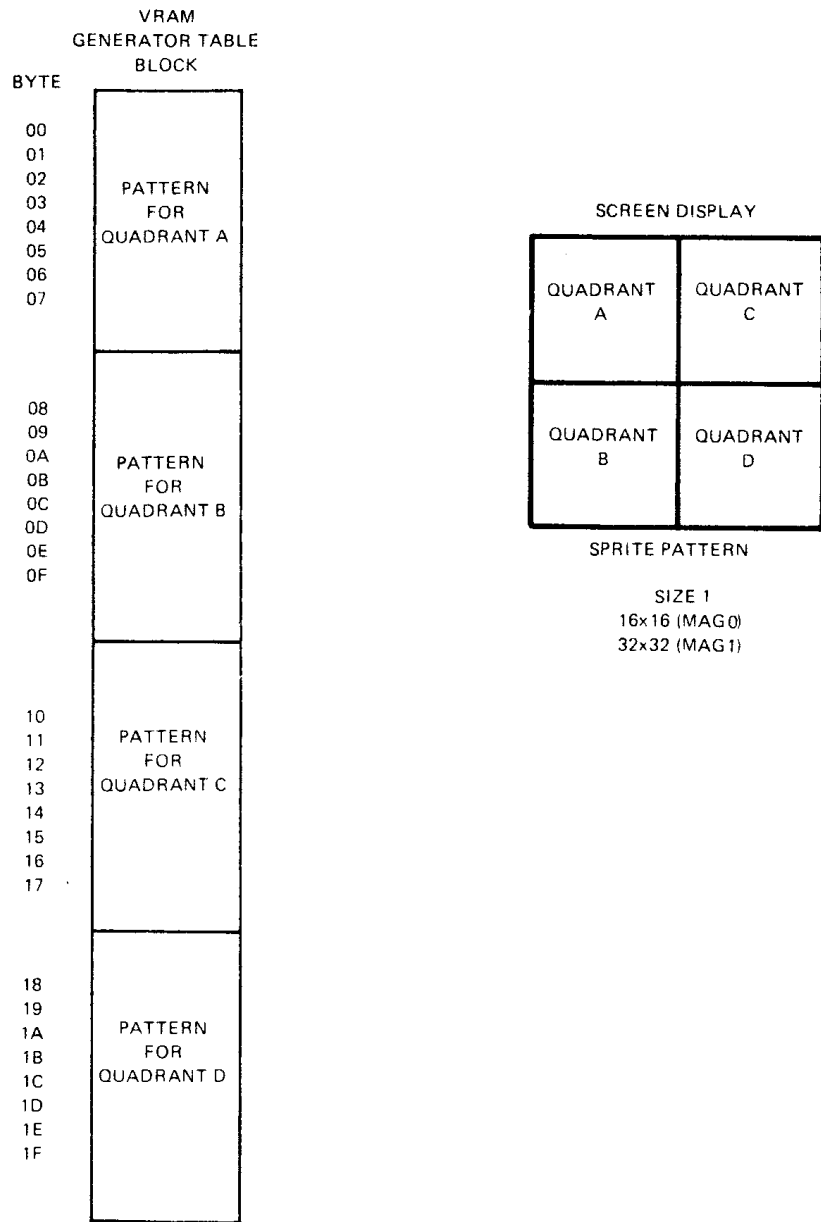

FIGURE 2-21 — SIZE 1 SPRITE MAPPING

2.4.6 A Step-by-Step Approach to Create Patterns and Sprites

PATTERNS

1. Use an 8×8 pattern similar to that in Figure A. Each small square represents one pixel on the screen.

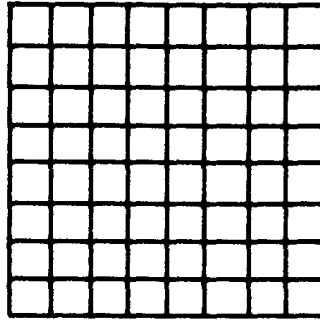

FIGURE A

2. Fill in the blocks to create your text character or graphics pattern. Examples of the letter A and an ARROW are shown in Figures B and C.

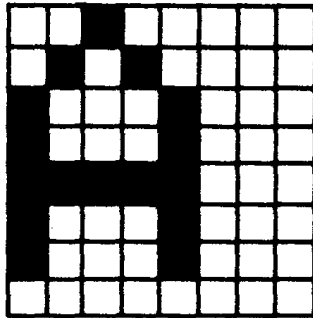

FIGURE B

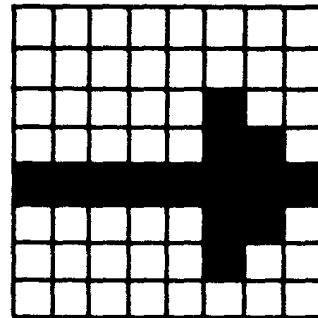

FIGURE C

NOTE

If these patterns are to be used in the Text mode, (40 patterns per line), the pattern should be inside a left-justified 6×8 block like the A shown in Figure B. If all of the Text patterns are inside this 6×8 block, they can be used for Text and Graphics 1 and 2 modes.

3. Assign 1s to the filled-in areas and 0s to the blanks. Then convert the 1s and 0s to their hexadecimal equivalents, as shown in Figure D.

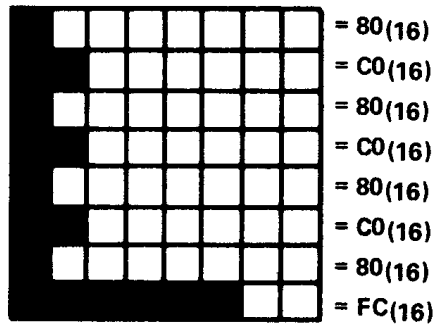
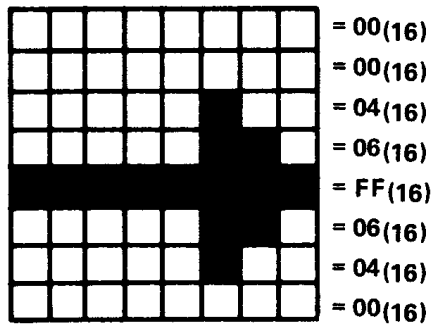
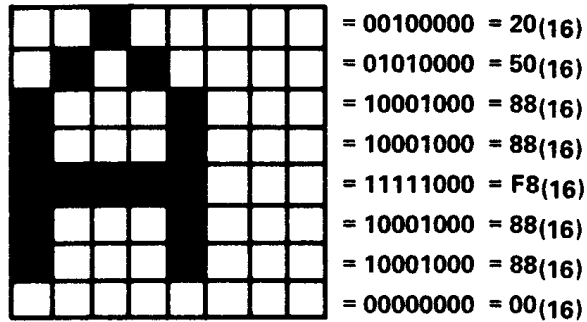

FIGURE D

4. Now place the eight bytes defining the pattern into the Pattern Generator Table. Assume the Pattern Generator Table sub-block is located at 800_{16} and the arrow pattern is to be named 00_{16} . Then place the eight pattern bytes as follows:

800		}	PATTERN NAME 00
801	00		
802	04		
803	06		
804	FF		
805	06		
806	04		
807	00		
808		}	PATTERN NAME 01
809			
80A			
80B			
80C			
80D			
80E			
80F			
810		}	PATTERN NAME 20
900	00		
901	00		
902	00		
903	00		
904	00		
905	00		
906	00		
907	00		
908		}	PATTERN NAME 41
A08	20		
A09	50		
A0A	88		
A0B	88		
A0C	F8		
A0D	88		
A0E	88		

NOTE

When using text in your applications, you can place the eight bytes of the text character in its ASCII number location.

Example: ASCII SPACE = 20_{16}
 ? = $3F_{16}$
 A = 41_{16}
 B = 42_{16}
 C = 43_{16}
 Etc.

This simplifies writing text to the screen. Simply write the ASCII name directly to the Pattern Name Table. A space character is shown in Pattern Generator Table position 20, and A is shown in pattern name 41.

SPRITES

1. Determine whether to use 8×8 or 16×16 sprite patterns. Then use the appropriate work pattern, as shown in Figures E and F.

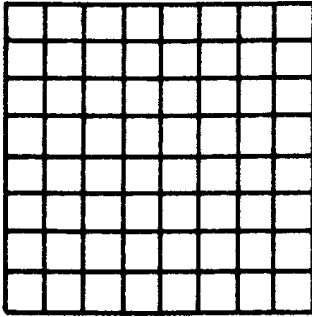

FIGURE E

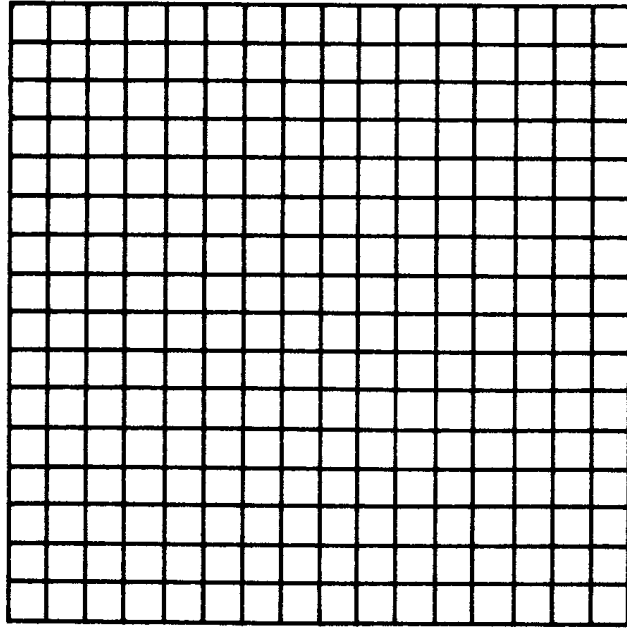

FIGURE F

2. Fill in the blocks to create your sprite pattern. Examples are shown in Figures G and H.

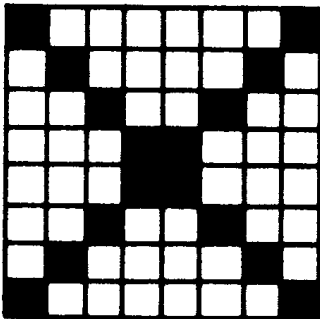

FIGURE G

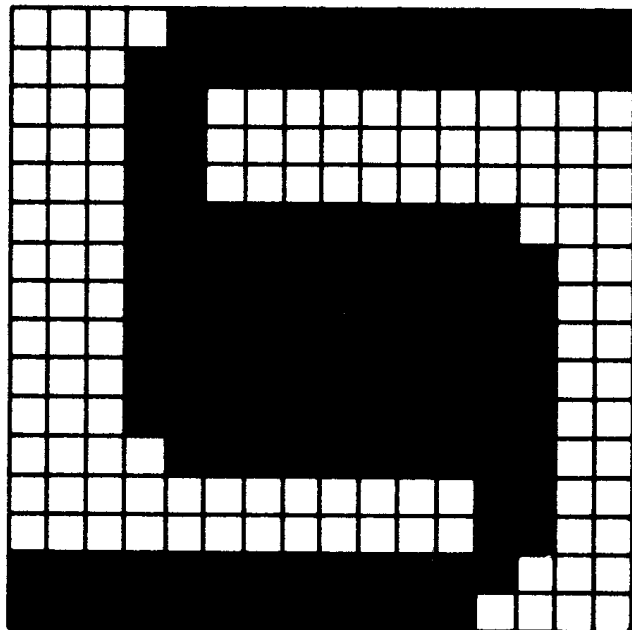

FIGURE H

3. Next encode the sprite patterns as in the Pattern Section. The 8×8 sprite encodes exactly as the 8×8 pattern, but the 16×16 sprite encodes as shown in Figure J.

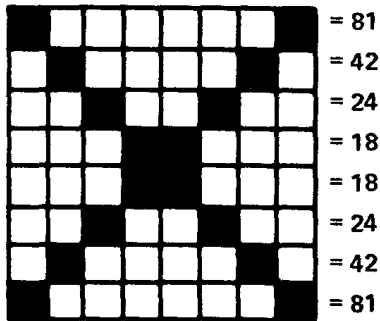

FIGURE I

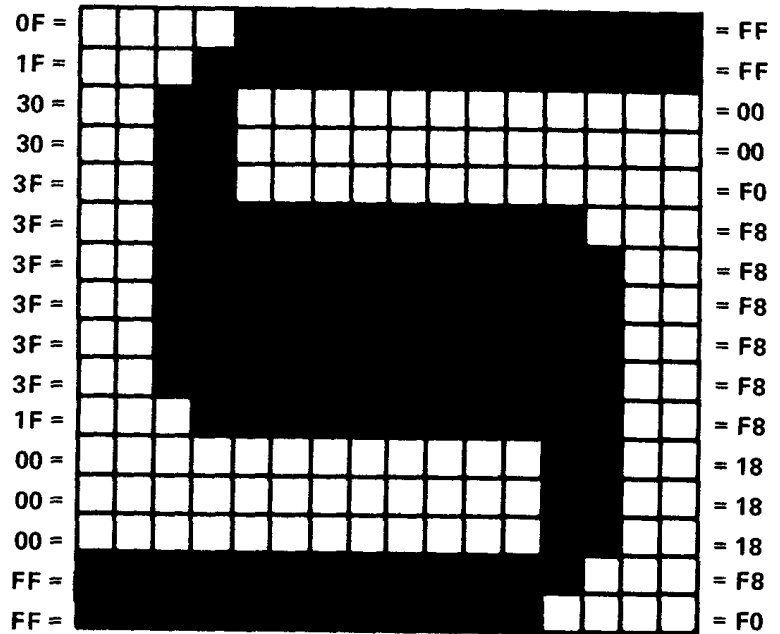

FIGURE J

Break the 16×16 block pattern into four 8×8 patterns. Next, encode the 8×8 patterns starting in the upper left corner, then do the lower left, upper right, and lower right.

4. Place the 8 bytes for 8×8 sprites or 32 bytes for 16×16 sprites in the Sprite Generator Table. Assuming the sprite generator table is located at location 0000, Figures K and L show how the tables should look for 8×8 and 16×16 sprites.

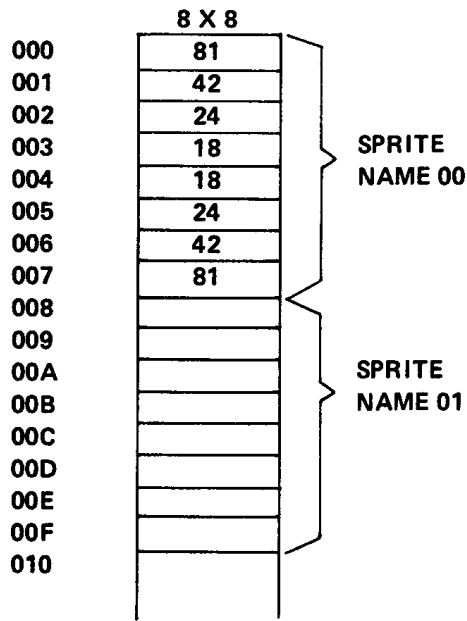

FIGURE K

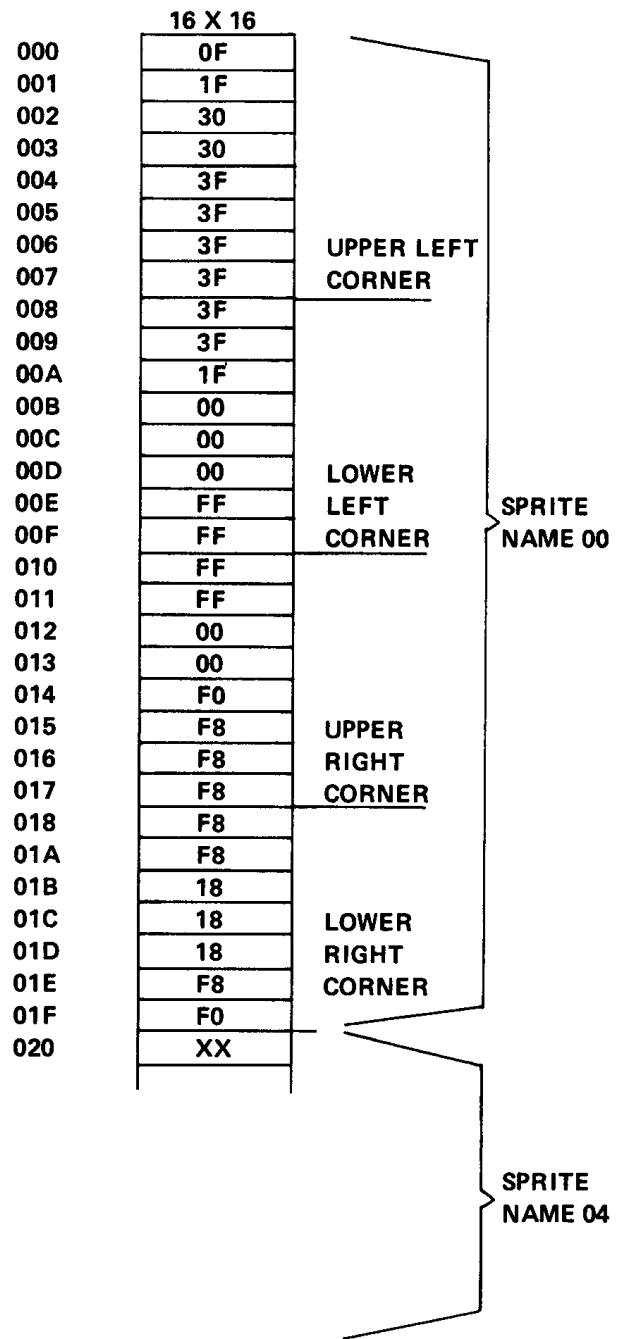

FIGURE L

16×16 sprite patterns start in the table with the byte from the upper left-hand corner. Then start with the upper right, going toward the lower right.

3. VDP INTERFACES AND OPERATION

3.1 VDP/VRAM INTERFACE

The VDP can access up to 16,384 bytes of VRAM using a 14-bit VRAM address. The VDP fetches data from the VRAM in order to process the video image described later. The VDP also stores data in or reads in data from the VRAM during a CPU-VRAM data transfer. The VDP automatically refreshes the VRAM.

3.1.1 VRAM Interface Control Signals

The VDP-VRAM interface consists of two 8-bit data buses (RD0-RD7 unidirectional, AD0-AD7 bidirectional) and three control lines, as shown in Figure 3-1. The VRAM outputs data to the VDP on the VRAM read data bus (RD0-RD7). The VDP outputs both the address and data to the VRAM over the VRAM address/data bus (AD0-AD7). The VRAM row address is output when \overline{RAS} is active (low). The column address is output when \overline{CAS} is active (low). Data is output to the VRAM when $\overline{R/W}$ is active (low).

3.1.2 VRAM Memory Types

The VDP can use 4027-type 4K, 4108-type 8K, or 4116-type 16K dynamic RAMs. The 4/16K bit in VDP register 1 is a 0 for 4027-type RAMs and a 1 for 4108- and 4116-type RAMs. There is a minor difference between the way 4027s and 4108s/4116s are wired to the VDP. In the 4027, all \overline{CE} pins are tied to ground. In the 4108/4116 the A6 lines on the 4116 and 4108 (the same pin as \overline{CE} on 4027's) are all tied to AD1 on the TMS9918A. A jumper can be used to select the VRAM type.

3.1.3 VDP to DRAM Address Connections

The VDP can be easily connected to either the 4027 or 4116 DRAMs. However, due to different pin numbering standards, it is possible to connect the VDP to the DRAMs incorrectly. Table 3-1 shows the recommended way to connect a VDP to either DRAM. Other DRAMs, such as the single +5 V supply type, can also be used by following the 4K or 16K columns in Table 3-1.

TABLE 3-1 – VDP TO DRAM ADDRESS CONNECTIONS

VDP	4116 or 16K	4027 or 4K
AD0	DATA ONLY	DATA ONLY
AD1	A6	DATA ONLY
AD2	A5	A5
AD3	A4	A4
AD4	A3	A3
AD5	A2	A2
AD6	A1	A1
AD7	A0	A0

When connecting the data ports together, ensure that corresponding RAMs (assuming 8 by 1 DRAMs) are properly connected to the corresponding input or output of the VDP. For example, AD0 of the corresponding input or output D input of the RAM, and RD0 of the VDP should connect to the Q output of the same RAM. The same is true for all AD and RD corresponding pins for each of the eight DRAMs.

NOTE

CD0 is the MSB of the CD bus; CD7 is the LSB.
AD0 is the MSB of the AD bus; AD7 is the LSB.
RD0 is the MSB of the RD bus; RD7 is the LSB.
RAMs have the reverse convention.
AD7 is the MSB of the AD bus, and AD0 is the LSB.

Therefore, AD7 of the VDP connects to AD of the 4116, and AD1 connects to A6. Data coming into the VDP on CD0 goes to VRAM on AD0 and returns to the VDP on RD0.

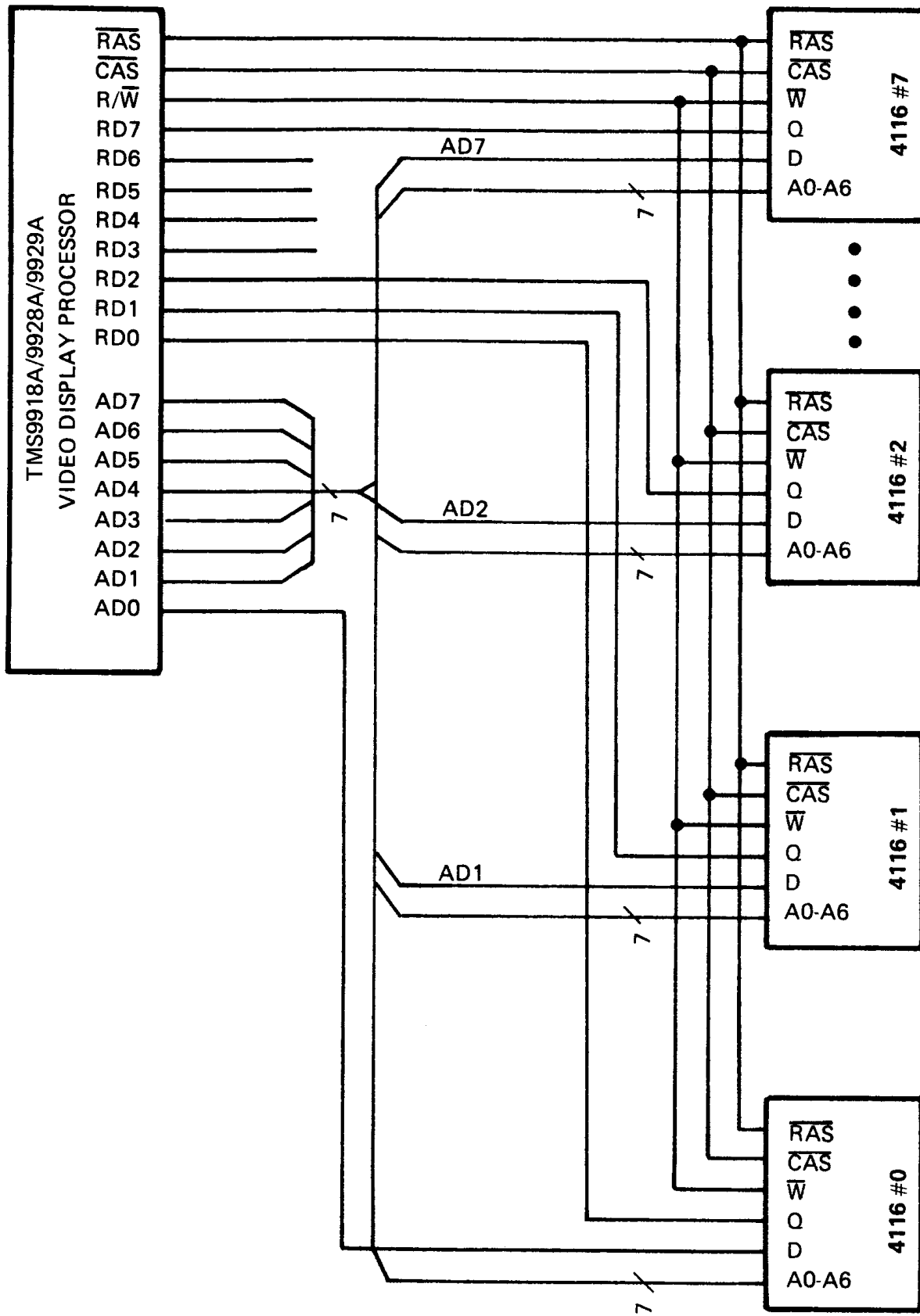

FIGURE 3-1 – VRAM INTERFACE

3.2 VRAM MEMORY ADDRESS DERIVATION

Table 3-2 summarizes the VRAM address derivation for all VDP modes of operation. Section 4 of this manual contains examples of how typical VRAM addresses are computed by the VDP.

TABLE 3-2 – PATTERN GRAPHICS ADDRESS LOCATION TABLES

GRAPHICS I MODE ADDRESS LOCATION

ADDRESS TYPE	0	1	2	3	4	5	6	7	8	9	10	11	12	13	COMMENTS
1) PATTERN NAME ADDRESS	NTB		ROW				COLUMN							PATTERN NAME TABLE BASE (VDP REG2) PATTERN POSITION	
2) PATTERN COLOR ADDRESS	COLB							0	NAME (0-4)						PATTERN COLOR TABLE BASE (VDP REG3) ALWAYS "0" IN BIT 8 FIVE MOST SIGNIFICANT BITS OF NAME
3) PATTERN GENERATOR ADDRESS	PGB		NAME						XXX					PATTERN GENERATOR BASE (VDP REG4) ALL 8 BITS OF NAME THREE LSB'S FORM PATTERN ROW POSITION	

GRAPHICS II MODE ADDRESS LOCATION

ADDRESS TYPE	0	1	2	3	4	5	6	7	8	9	10	11	12	13	COMMENTS
1) PATTERN NAME ADDRESS	NTB		ROW				COLUMN							PATTERN NAME TABLE BASE (VDP REG2) PATTERN POSITION ROW PATTERN POSITION COLUMN	
2) PATTERN COLOR ADDRESS		XX		NAME						XXX					PATTERN COLOR TABLE BASE MSB (VDP REG3) TWO MSB FROM VERTICAL COUNTER ALL 8 BITS OF NAME COLOR TABLE BYTE/LINE
3) PATTERN GENERATOR ADDRESS		XX		NAME						XXX					PATTERN NAME TABLE BASE MSB (VDP REG4) TWO MSB FROM VERTICAL COUNTER ALL 8 BITS OF NAME PATTERN GENERATOR BYTE/LINE NUMBER

TEXT MODE ADDRESS LOCATION

ADDRESS TYPE	0	1	2	3	4	5	6	7	8	9	10	11	12	13	COMMENTS
TEXT MODE NAME ADDRESS	NTB		TEXT POSITION												PATTERN NAME TABLE BASE (VDP REG2) EQUAL (TEXT POSITION ROW # TIMES 40) PLUS (TEXT POSITION COLUMN NUMBER)
TEXT MODE PATTERN ADDRESS	PGB		NAME						XXX					PATTERN GENERATOR BASE (VDP REG4) NAME BYTE/LINE NUMBER	

TABLE 3-2 – PATTERN GRAPHICS ADDRESS LOCATION TABLES (CONTINUED)

SPRITE ADDRESS LOCATION

ADDRESS TYPE	0	1	2	3	4	5	6	7	8	9	10	11	12	13	COMMENTS
SPRITE ATTRIBUTE ADDRESS	SAB						SPRITE				XX			SPRITE ATTRIBUTE TABLE BASE (VDP REG5) SPRITE NUMBER ATTRIBUTE NUMBER: 00 FOR VERTICAL POSITION 01 FOR HORIZONTAL POSITION 10 FOR NAME 11 FOR TAG (EARLY CLOCK AND COLOR)	
SIZE = 0 SPRITE PATTERN GENERATOR	SPGB		NAME						XXX			SPRITE PATTERN GENERATOR BASE (VDP REG4) NAME ATTRIBUTE OF SPRITE THREE LSB'S GIVE BYTE/LINE NUMBER			
SIZE = 1 SPRITE PATTERN GENERATOR	SPGB		NAME (0-5)				XXXXX				SPRITE PATTERN GENERATOR BASE (VDP REG4) SIX MSB OF NAME SIZE = 1 SPRITE BYTE NUMBER (SEE FIGURE 4-4)				

MULTICOLOR ADDRESS LOCATION

ADDRESS TYPE	0	1	2	3	4	5	6	7	8	9	10	11	12	13	COMMENTS
4) MULTICOLOR NAME ADDRESS	NTB			ROW					COLUMN				NAME TABLE BASE (VDP REG2) PATTERN POSITION ROW PATTERN POSITION COLUMN		
5) MULTICOLOR COLOR GENERATOR ADDRESS	PGB		NAME						XXX			PATTERN GENERATOR BASE (VDP REG4) NAME FROM NAME FETCH THREE LSB'S FORM BYTE/SQUARE ROW			

The TMS9918A/9928A operates at 262 lines per frame and approximately 60 frames per second in a noninterlaced mode of operation. The TMS9929A operates at 313 lines per frame and approximately 50 frames per second in a noninterlaced mode of operation.

3.3 VRAM ADDRESSING EXAMPLE

A typical application might require up to 256 unique 8 × 8 patterns with no more than 2 colors per pattern and up to 32 8 × 8 sprites.

These conditions dictate in which mode the VDP is to be used. The sprite requirement and the 8 × 8 pattern blocks eliminate the text and multicolor modes, respectively. This leaves only the Graphics I and Graphics II modes, and since two colors per block are all that are necessary, Graphics I is employed due to its ease of use.

Figure 3-2 shows a memory map that allows these functions to fit into a 4K memory area.

Register values for Figure 3-2 are as follows:

- Register 0 = 00 External VDP disabled, M3 = 0
- Register 1 = C0 16K DRAM selected, Blank = 1, Graphics 1 mode selected, SIZE = 0, MAG = 0
- Register 2 = 01 Name Table Start Address @ > 400
- Register 3 = 08 Color Table Start Address @ > 0200
- Register 4 = 01 Pattern Generator Start Address @ > 800
- Register 5 = 02 Sprite Attribute Table Start Address > 100
- Register 6 = 00 Sprite Pattern Generator Start Address @ > 0000
- Register 7 = XX Determined by user.

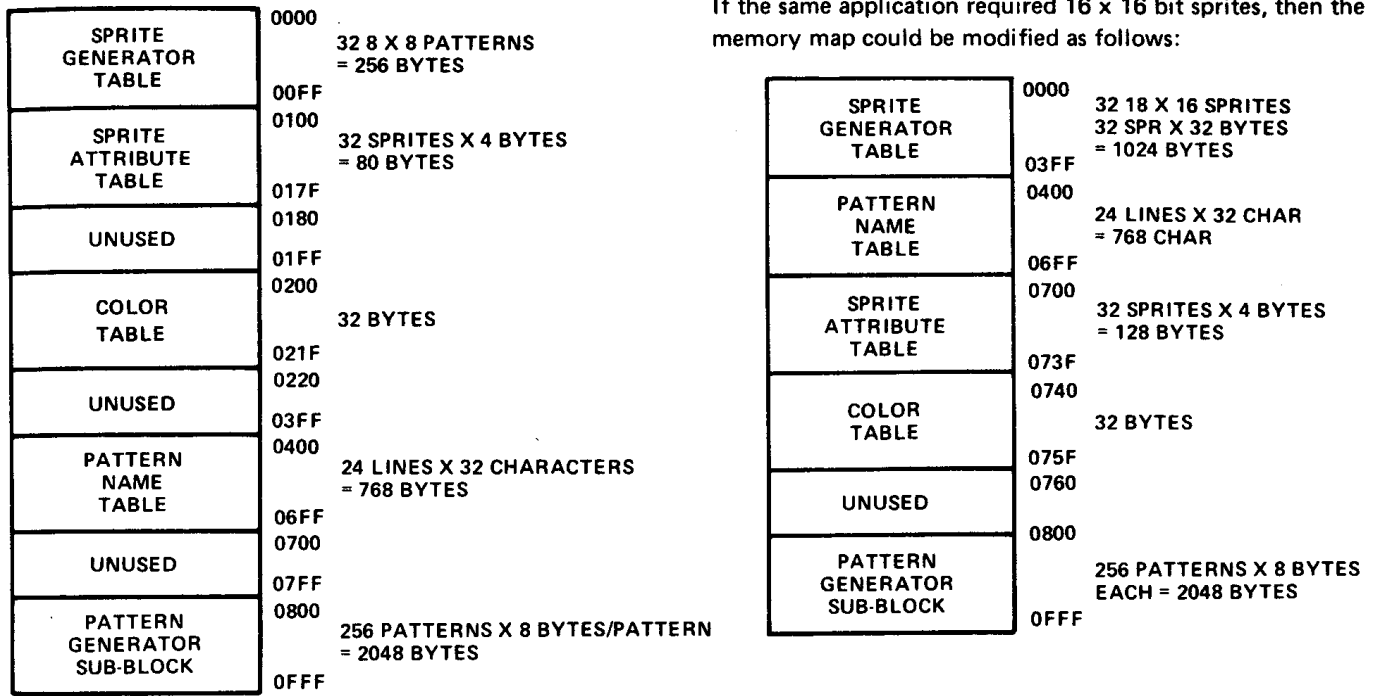

FIGURE 3-2 — VDP-VRAM MEMORY ALLOCATION

3.4 MONITOR INTERFACES

3.4.1 TMS9918A Monitor Interface

The composite video output signal from the TMS9918A drives a color monitor. This signal incorporates all necessary horizontal and vertical synchronization signals as well as luminance and chrominance information. In monitor applications, the requirements of the monitor should be studied to determine if the VDP can be connected directly to it. The internal output buffer device on the composite video pin is a source-follower MOS transistor that requires an external pull-down resistor to V_{SS} as shown in Figure 3-3. Typically a 330-ohm resistor is recommended to provide a 1.9-volt synchronization level. The load resistor (RL) defines the sharpness of the edges on the video signals. A lower resistor value gives faster fall times and a sharper picture.

In some cases, it may be necessary to provide a simple interface circuit to match the VDP output voltages with the monitor specifications. To drive a standard television that is not outfitted with a composite video input, the signal can be run into the television antenna terminals by using an appropriate RF modulator on the VDP output. Take care to ensure a proper match between VDP, RF modulator, and TV.

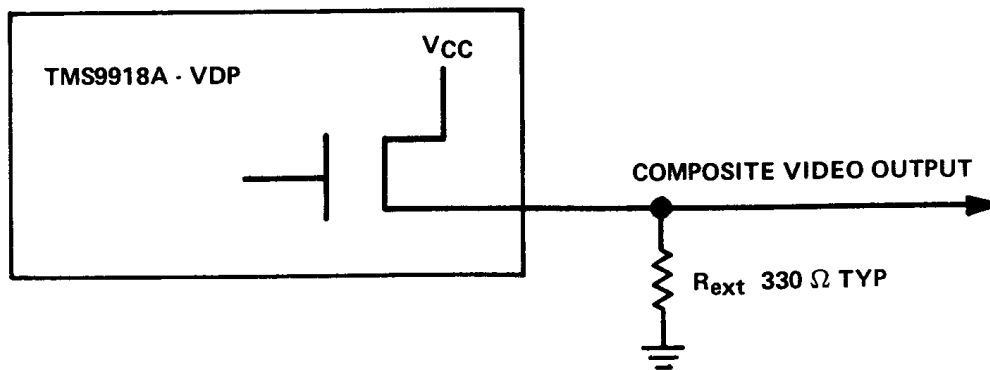
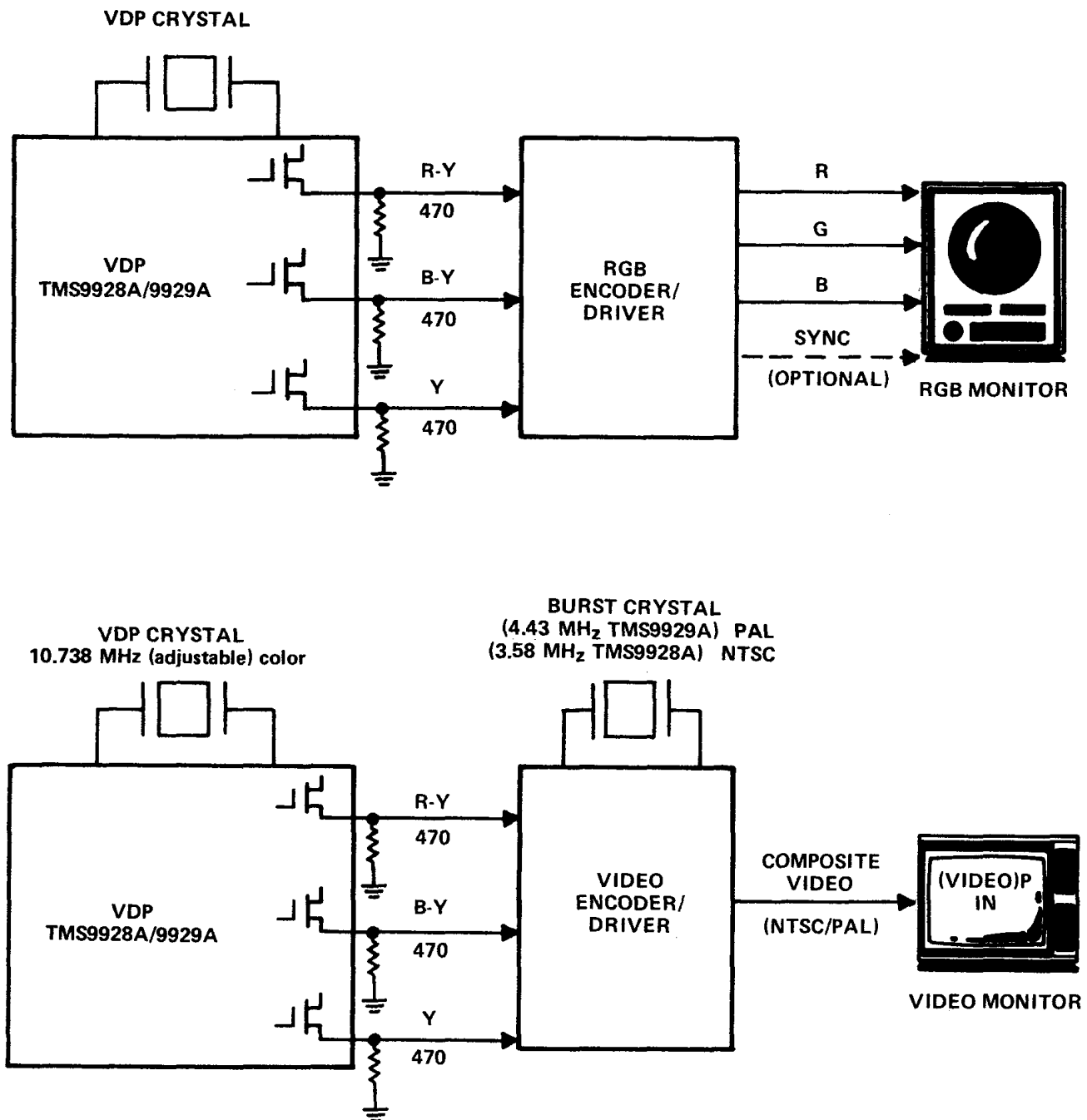

FIGURE 3-3 — COMPOSITE VIDEO PULL-DOWN CIRCUIT

3.4.2 TMS9928A/9929A Monitor Interface

The Y, R-Y and B-Y output signals require external encoder circuitry to drive a video color monitor; an R-G-B matrix circuitry is required to drive R-G-B color monitors. The Y output signal contains all necessary horizontal and vertical synchronization signals as well as luminance while the R-Y and B-Y signals contain the unmodulated chrominance information and are used in the NTSC and PAL systems to modulate two carriers in quadrature. The internal output buffer devices on these pins are source-follower MOS transistors that require an external pull-down resistor to V_{SS} , as shown in Figure 3-4. A 330 ohm resistor is recommended.



NOTE: The LM1889 is typically used in the video encoder circuitry.

FIGURE 3-4 — USE OF TMS9928A/9929A WITH DIFFERENT MONITORS

3.5 TMS9918A EXTERNAL VDP OPERATION

The external VDP interface allows cascading multiple VDPs. Figures 3-5 and 3-6 illustrate cascading two VDPs. Note that the VDPs must be reset by a common reset source to assure synchronization on an open loop basis. This reset source should have fast edges so that rise and fall times are less than 30 ns. Occasionally, synchronization is not obtained after reset, in which case, reset should be reapplied.

The video matching circuit ensures that the video signal of external VDP is biased correctly and of the proper amplitude. This ensures the luminance levels of the external and VDP colors are matched and external VDP video does not bleed through into the composite video output of the first VDP. The internal circuit assures that a perfect match results if the external video is of the same amplitude as the composite video of the VDP and its dc level is increased by a MOS threshold voltage (typically 0.7 volts). This adjustment can be varied to change the relative luminance levels of the two video signals and thus modify the picture appearance.

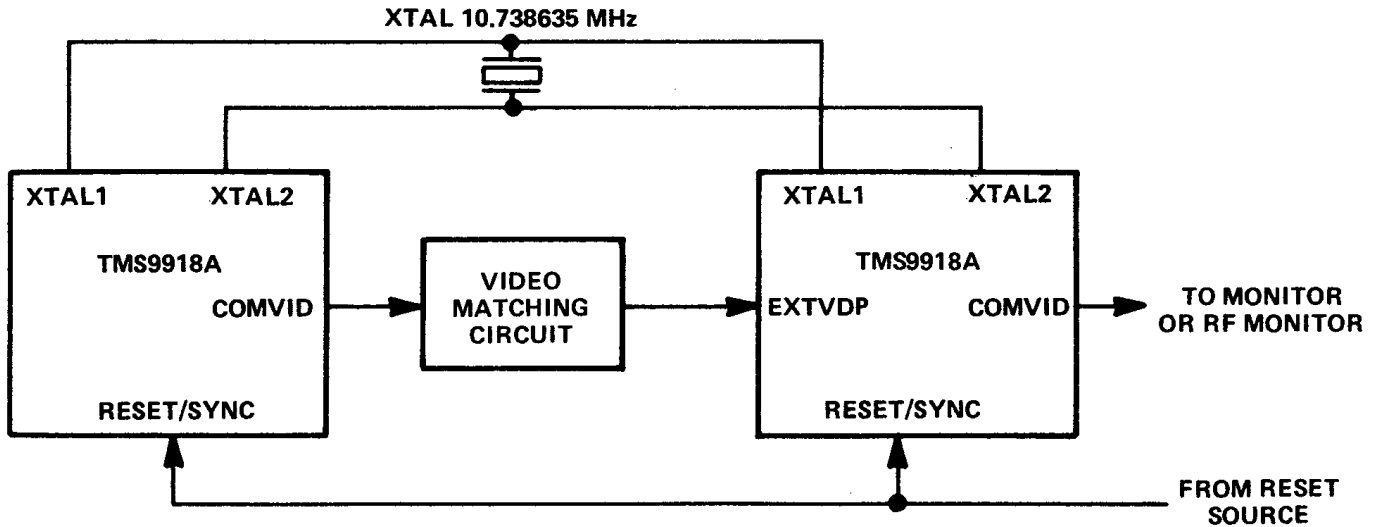

FIGURE 3-5 — CASCADING TWO TMS9918A VDPs

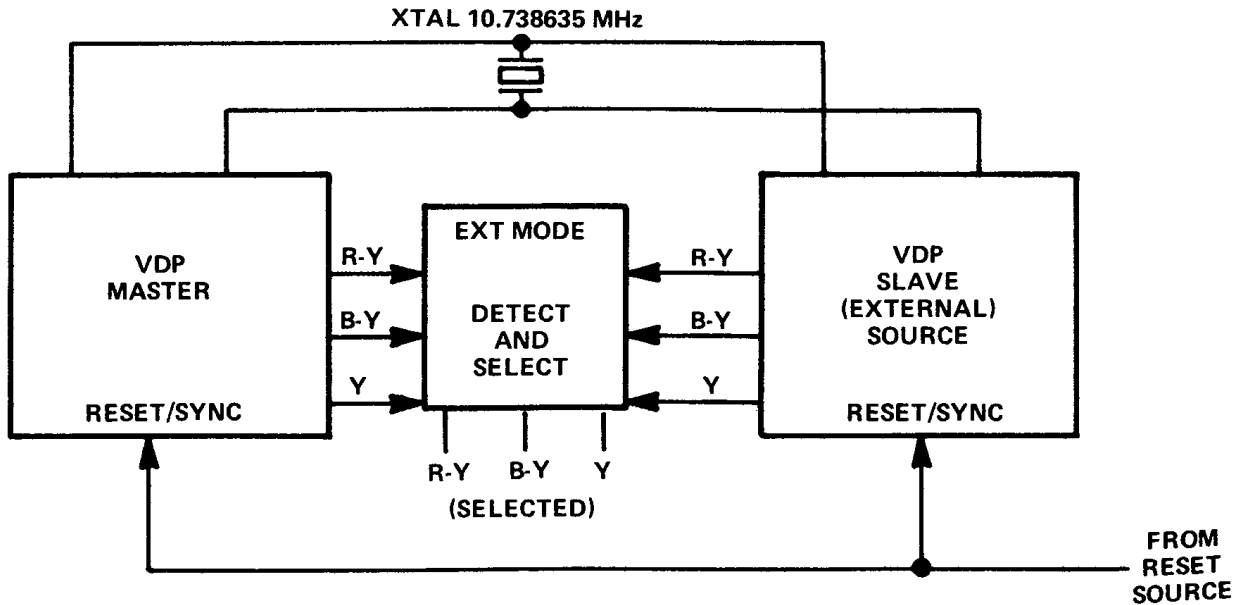

FIGURE 3-6 — CASCADING TWO TMS9918A/9929A VDPs

For the External VDP input plane to be visible, the External VDP Enable bit in VDP Register 0 (EXVID) should be set to a 1. The backdrop color (VDP Register 7, lower 4 bits) should be set to transparent (0). For the external VDP plane to show through at a given spot on the screen, the pattern color at that spot should be transparent, and all sprites should not be in the way (alternatively, a sprite that was in the way could be made transparent in color). Note that the external VDP feature can be used in either Graphics I, Graphics II, Text, or Multicolor mode.

3.6 OSCILLATOR AND CLOCK GENERATION

The VDP is designed to operate with a 10.738635 (± 0.005) MHz crystal input to generate the required internal clock signals. A fundamental-frequency parallel-mode crystal is the frequency reference for the internal clock oscillator, which is the master time base for all system operations. This master clock is divided by two to generate the pixel clock (5.3 MHz) and by three to provide the CPUCLK (3.58 MHz for TMS9918A only). The GROMCLK is developed from the master clock frequency divided by 24 (3.58 MHz for TMS9928A only).

3.6.1 TMS9918A Color Phase Generation

The 10.7 + MHz master clock and its complement generate an internal six-phase 3.579545 MHz (± 10 Hz) clock to provide the video color signals and the color burst reference used in developing the composite video output signal. While the VDP signals are not exact equivalents to the standard NTSC colors, the differences can easily be adjusted with the color and tint controls of the target color monitor.

3.6.2 Video Sync and Control Generation

Decoding the outputs of the horizontal and vertical counters generates the horizontal and vertical control signals. The pixel clock drives the horizontal counter which in turn increments the vertical counter.

Table 3-3 gives the relative count values of the screen display parameters. Within the active display area during Graphics I mode, the three LSBs of the horizontal counter address the individual picture element of each pattern displayed. Also, during the vertical active display period, the three LSBs of the vertical counter address each individual line in the 8 \times 8 patterns. The Graphics II, Multicolor and Text modes use the counters similarly.

The TMS9918A/9929A operates at 262 lines per frame and approximately 60 frames per second in a noninterlaced mode of operation. The TMS9929A operates at 313 lines per frame and approximately 50 frames per second in a noninterlaced mode of operation.

TABLE 3-3 — SCREEN DISPLAY PARAMETERS

PARAMETER	PIXEL CLOCK CYCLES	
	PATTERN OR MULTICOLOR	TEXT
HORIZONTAL		
HORIZONTAL ACTIVE DISPLAY	256	240
RIGHT BORDER	15	25
RIGHT BLANKING	8	8
HORIZONTAL SYNC	26	26
LEFT BLANKING	2	2
COLOR BURST	14	14
LEFT BLANKING	8	8
LEFT BORDER	13	19
	342	342
VERTICAL	LINE	
VERTICAL ACTIVE DISPLAY	192	
BOTTOM BORDER	24	
BOTTOM BLANKING	3	
VERTICAL SYNC	3	
TOP BLANKING	13	
TOP BORDER	27	
	262	

3.7 VDP TERMINAL ASSIGNMENTS

3.7.1 TMS9918A Terminal Assignments

SIGNATURE	TERMINAL	I/O	DESCRIPTION
XTAL1, XTAL2	40,39	I	10.7 + MHz crystal inputs*
CPUCLK	38	O	VDP color burst frequency clock. Typically not used on the TMS9918A, this is the color burst frequency clock.
GROMCLK	37	O	VDP output clock = XTAL/24. Typically not used.
COMVID	36	O	Composite video output for the TMS9918A.
EXTVDP	35	I/O	On the TMS9918A, this is the external VDP input.
$\overline{\text{RESET}}/$ SYNC	34	I	The $\overline{\text{RESET}}$ pin is a trilevel input pin. When it is below 0.8 volts, RESET initializes the VDP. When it is above 9 volts, RESET is the synchronizing input for external video.
VCC	33	I	+ 5 volt supply
RD0 MSB	32	I	VRAM read data bus
RD1	31	I	
RD2	30	I	
RD3	29	I	
RD4	28	I	
RD5	27	I	
RD6	26	I	
RD7	25	I	
CD0 MSB	24	I/O	CPU data bus; (CD0) is the most significant bit
CD1	23	I/O	
CD2	22	I/O	
CD3	21	I/O	
CD4	20	I/O	
CD5	19	I/O	
CD6	18	I/O	
CD7 LSB	17	I/O	
$\overline{\text{INT}}$	16	O	CPU interrupt output.
$\overline{\text{CSR}}$	15	I	CPU-VDP read strobe
$\overline{\text{CSW}}$	14	I	CPU-VDP write strobe
MODE	13	I	CPU interface mode select; usually a processor address line

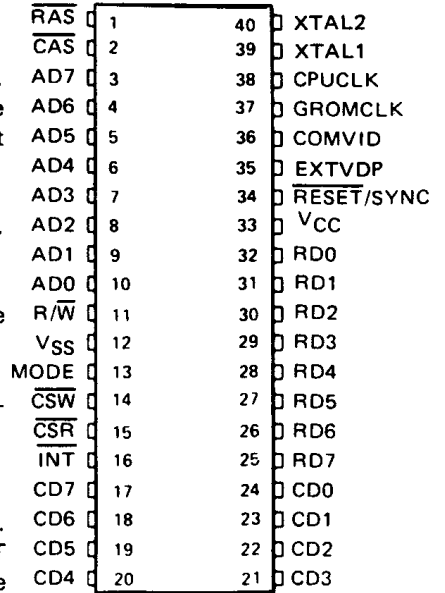

* When driven externally, both inputs must be driven.

** The least significant address bit (AD7) is wired to A0 of the dynamic RAMs. Likewise, AD6 is wired to A1 of the RAMs. Care must be exercised in assuring proper orientation of the TMS 9918A address outputs to the dynamic RAM address inputs.

TMS9918A Terminal Assignments (continued)

SIGNATURE	TERMINAL	I/O	DESCRIPTION
VSS	12	I	Ground References
$\overline{R/\overline{W}}$	11	O	VRAM write strobe
AD0 MSB	10	O	VRAM address/data bus (multiplexed high and low order VRAM address and output data bytes)
AD1	9	O	AD0 is the most significant bit and is used only for data and not for addressing.**
AD2	8	O	
AD3	7	O	
AD4	6	O	
AD5	5	O	
AD6	4	O	
AD7	3	O	
\overline{CAS}	2	O	
\overline{RAS}	1	O	VRAM row address strobe

* When driven externally, both inputs must be driven.

** The least significant address bit (AD7) is wired to A0 of the dynamic RAMs. Likewise, AD6 is wired to A1 of the RAMs. Care must be exercised in assuring proper orientation of the TMS 9918A address outputs to the dynamic RAM address inputs.

3.7.2 TMS9928A/9929A Terminal Assignments

SIGNATURE	TERMINAL	I/O	DESCRIPTION
XTAL1, XTAL2	40,39	I	10.7 + MHz crystal inputs*
R-Y	38	O	VDP color burst frequency clock. On the TMS9928A/9929A, this is the R-Y color difference output.
GROMCLK	37	O	VDP output clock = XTAL/24. Typically not used.
Y	36	O	Composite video output. On the TMS9928A/9929A, this is the Y (black/white luminance and composite sync) output.
B-Y	35	I/O	External VDP input. On the TMS9928A/9929A, this is the B-Y color difference output.
$\overline{\text{RESET}}/$ SYNC	34	I	The $\overline{\text{RESET}}$ pin is a trilevel input pin. When it is below 0.8 volts, RESET initializes the VDP. When it is above 9 volts, RESET is the synchronizing input for external video.
VCC	33	I	+5 volt supply
RD0 MSB RD1 RD2 RD3 RD4 RD5 RD6 RD7	32 31 30 29 28 27 26 25	I I I I I I I	VRAM read data bus
CD0 MSB CD1 CD2 CD3 CD4 CD5 CD6 CD7 LSB	24 23 22 21 20 19 18 17	I/O I/O I/O I/O I/O I/O I/O	CPU data bus; (CD0) is the most significant bit
$\overline{\text{INT}}$	16	O	CPU interrupt output.
$\overline{\text{CSR}}$	15	I	CPU-VDP read strobe
$\overline{\text{CSW}}$	14	I	CPU-VDP write strobe
MODE	13	I	CPU interface mode select; usually a processor address line

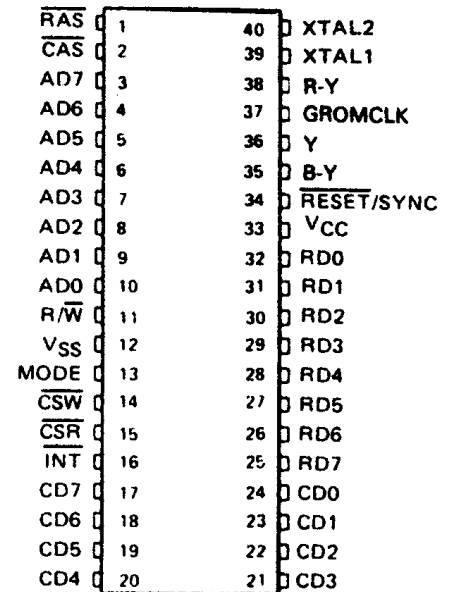

* When driven externally, both inputs must be driven.

** The least significant address bit (AD7) is wired to A0 of the dynamic RAMs. Likewise, AD6 is wired to A1 of the RAMs.

SIGNATURE	TERMINAL	I/O	DESCRIPTION
VSS	12	I	Ground References
R/ \overline{W}	11	O	VRAM write strobe
AD0 MSB	10	O	VRAM address/data bus (multiplexed high and low order VRAM address and output data bytes)
AD1	9	O	AD0 is the most significant bit and is used only for data and not for addressing.**
AD2	8	O	
AD3	7	O	
AD4	6	O	
AD5	5	O	
AD6	4	O	
AD7	3	O	
\overline{CAS}	2	O	
\overline{RAS}	1	O	VRam row address strobe

* When driven externally, both inputs must be driven.

** The least significant address bit (AD7) is wired to A0 of the dynamic RAMs. Likewise, AD6 is wired to A1 of the RAMs.

3.7.3 TMS9918A/9928A/9929A Crystals

Crystals for the TMS9918A/9928A/9929A can be purchased from the following:

NDK
 10080 North Wolfe Rd
 Suite 220
 Cupertino, CA 95014
 Telephone:
 (408)255-0831
 Telex: 352057

CTS Knights, Inc.
 400 Reiman Ave
 Sandwich, Ill 60548
 Telephone:
 (815)786-8411

4. DEVICE APPLICATIONS

This section describes the hardware and software interface between a TMS9918A/9928A/9929A VDP and a TMS9900 microprocessor. Some considerations in the use of the VDP for text and graphics applications are also described.

4.1 VDP TO TMS9900 INTERFACE

The circuit shown in Figure 4-1 illustrates a very simple interface between a TMS9900 microprocessor and a TMS9918A/9928A/9929A. In this circuit, the VDP 8-bit data bus is connected to the 8 MSBs of the TMS9900 16-bit data bus. For mode selection, A14 of the TMS9900 is connected to the mode input pin. Read and write signals to the VDP are as follows:

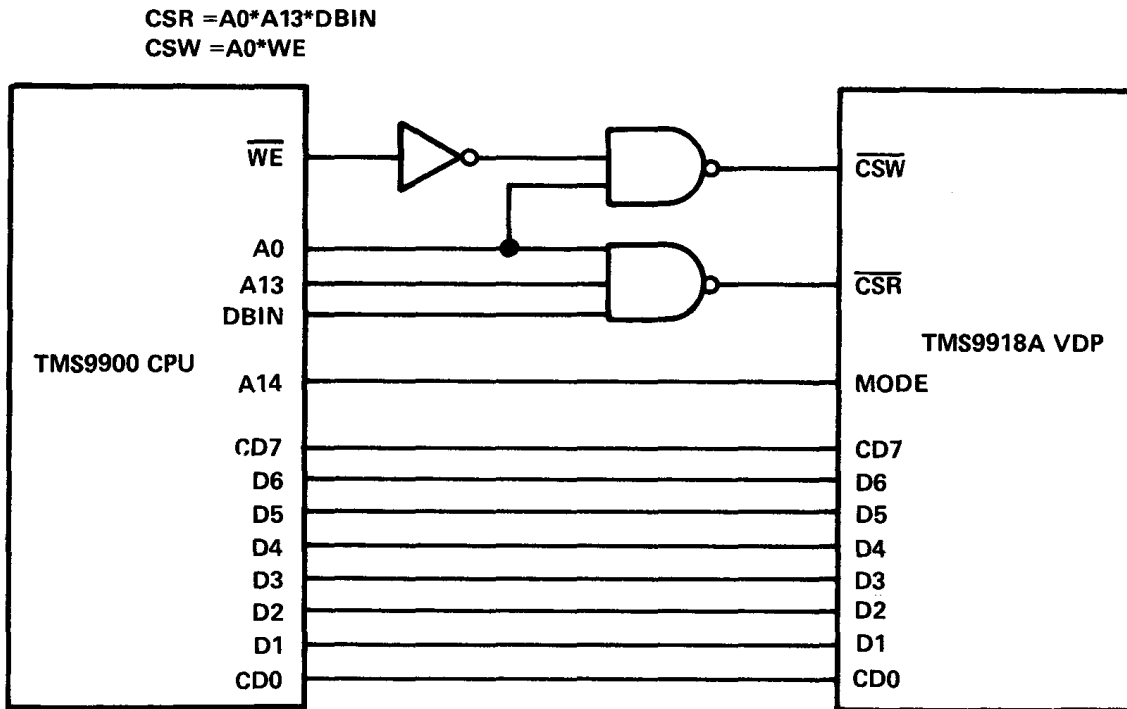

FIGURE 4-1 – MINIMUM SYSTEM INTERFACE TO TMS9900

DBIN and \overline{WE} are signals from the TMS9900 which indicate direction flow on the data bus. DBIN is high when the CPU is attempting to do a read data operation, while \overline{WE} is low when the CPU is outputting data onto the data bus.

A0 is used as a VDP select signal. Thus, the VDP is activated whenever the CPU is reading or writing data in the upper half of its address space (> 8000 and above). All addresses above > 8000 then become VDP port addresses. However, in a more sophisticated design, more decoding of the address lines would be done to select only those unique addresses required by the VDP. The purpose of A13 and decoding logic is to generate unique addresses for read and write operations and to block out the read data operation that occurs on the TMS9900 before a write data operation. Without this blockout logic, a pulse on the CSR input would occur before any desired pulsing of the CSW input, thus causing unwanted operation of the VDP. Referring to Table 4-1 and Figure 4-1, the following port addresses can be defined.

TABLE 4-1 – VDP PORT ADDRESSES FOR FIGURE 4-1

OPERATION	\overline{CSW}	\overline{CSR}	MODE	PORT
Write data to VRAM	0	1	0	>8000
Write address to VRAM or Write to VDP register	0	1	1	>8002
Read data from VRAM	1	0	0	>8004
Read VDP status	1	0	1	>8006

4.2 TMS9918A/9928A/9929A INTERFACE

Figures 4-2 and 4-3 show the hardware components necessary to make the VDP operate with a typical TM990 16-bit bus application. The CPU can be connected as shown to any general-purpose 8-bit data bus and control signals that work with most microprocessors. The VDP interface timing is similar to that of static memories and occupies eight unique memory address locations within the CPU memory address space.

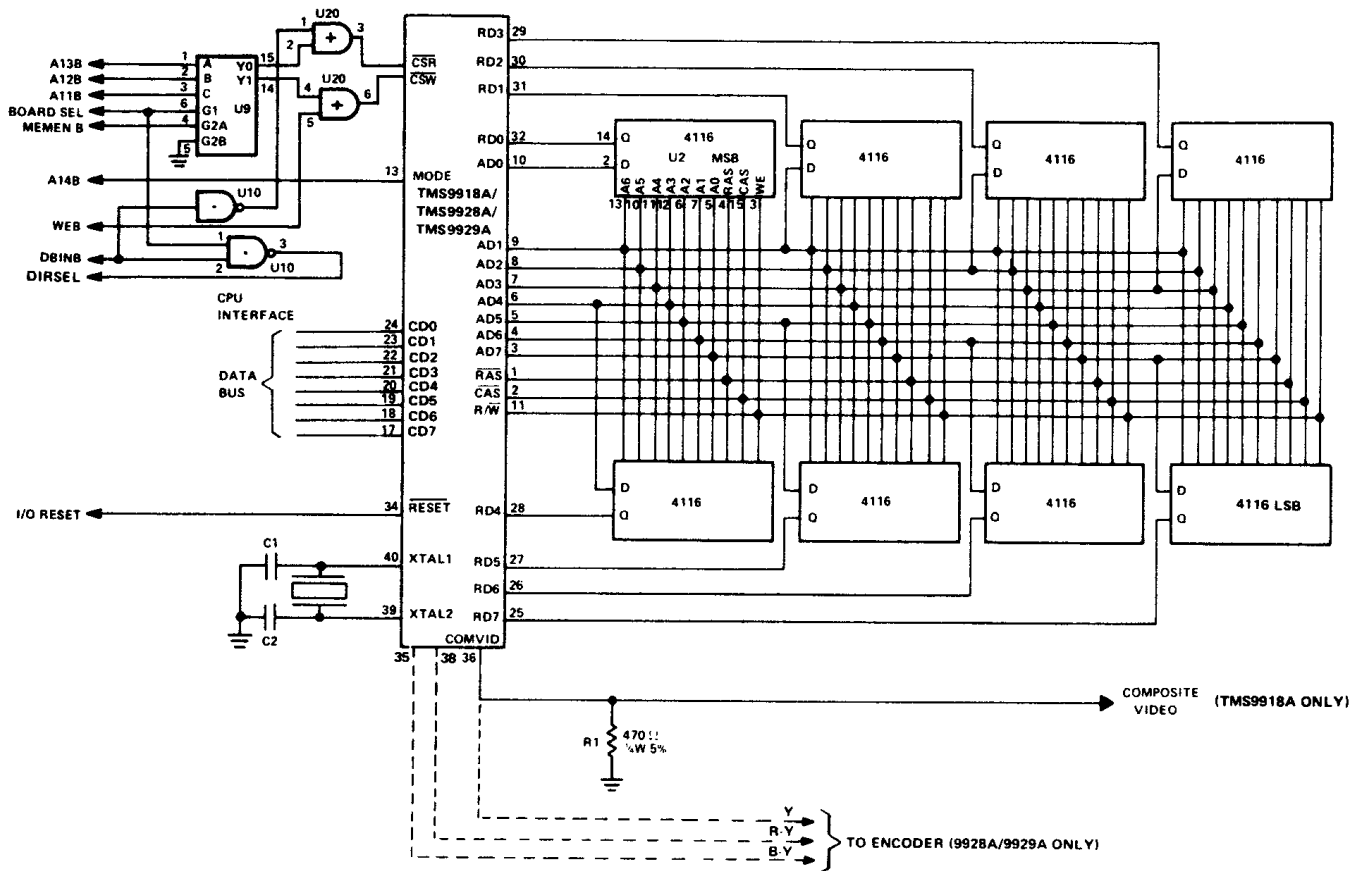

FIGURE 4-2 — TMS9918A/9928A/9929A INTERFACE

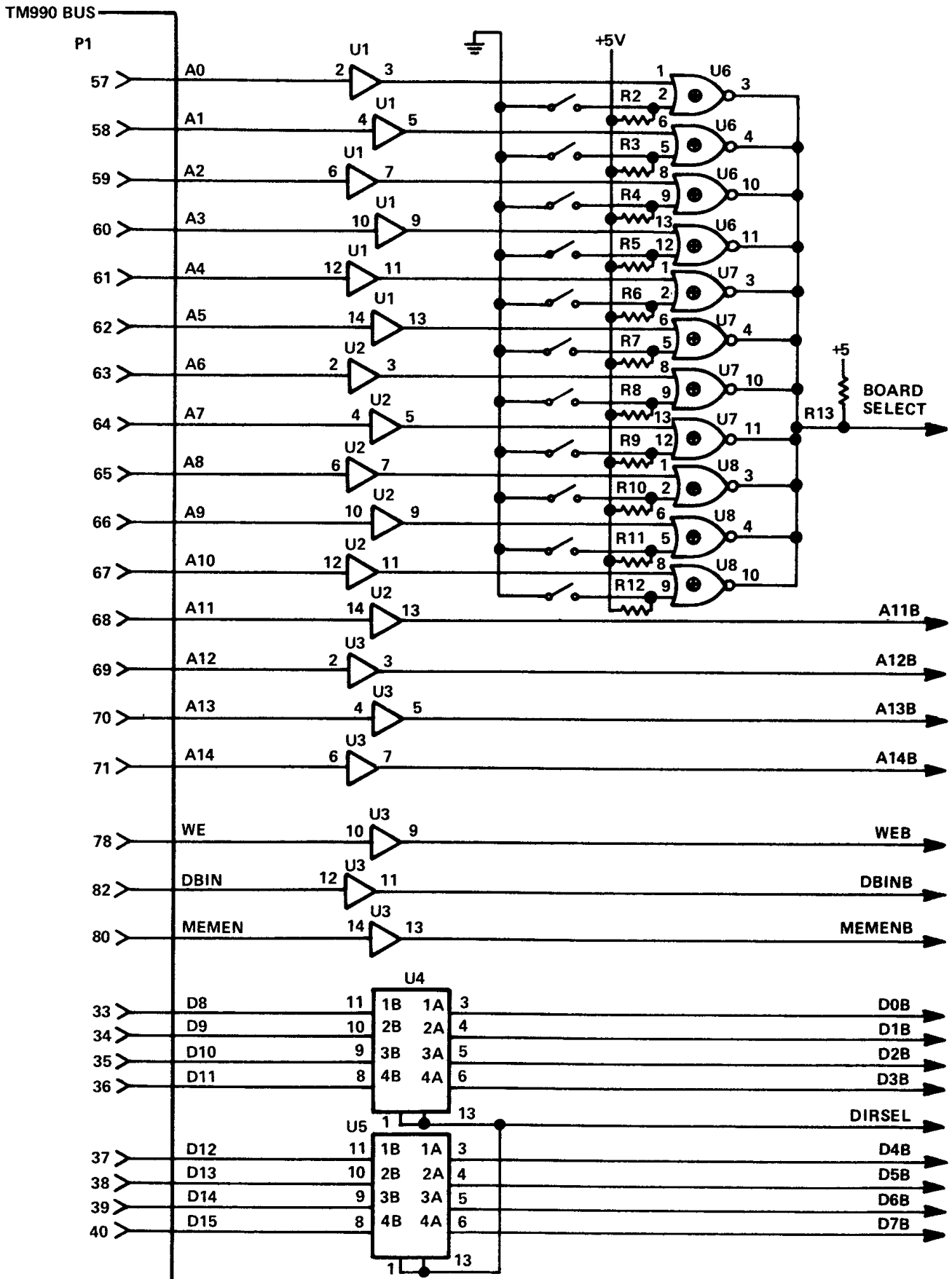

FIGURE 4-3 – TM990 (TMS9918A/9928A/9929A) DEMO BOARD

4.2.1 TM990 (TMS9918A/9928A/9929A) Parts List

U1,2,3	74LS367
U4,5	74LS243
U6,7,8	74LS266
U9	74LS138
U10	74LS00
U11	TMS9918A/9928A/9929A
U12-19	TMS4116
C1,2	33 pF
Y1	10.738635 MHz Crystal
SW1-3	4-position DIP Switches
R1	470 Ω 5% 1/4 W
R2-R13	Bourns XXXX or equivalent

NOTE: All power supply pins of each IC should be bypassed with a .1 μ F capacitor.

4.2.2 Composite Video Output

The TMS9918A composite video output pin (36), is driven by a source-follower MOS transistor that requires an external pull-down resistor to V_{SS} . A 470-ohm resistor is typically used to provide a 1.9 volt peak-to-peak signal on the output. This output will drive most color directly, although in some cases it may be necessary to provide a simple interface circuit to match the monitor's input requirements. If a color video monitor is not available, an RF modulator can be used to drive the antenna terminals of a standard color television, as shown in Figure 4-4.

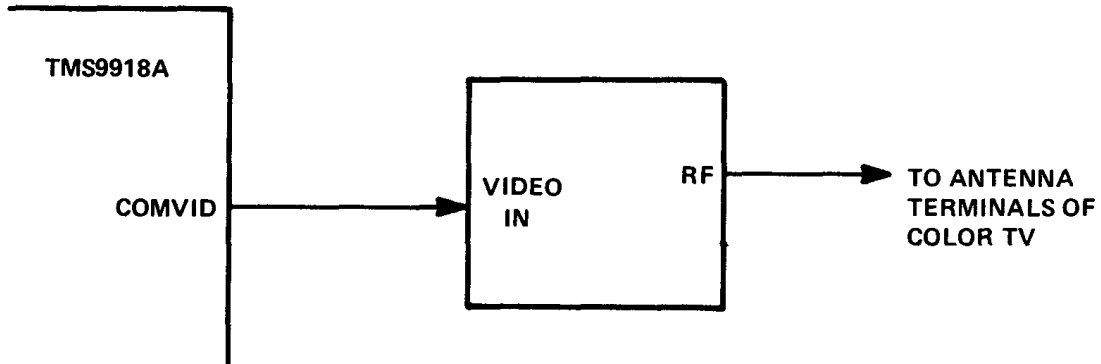

FIGURE 4-4 – RF MODULATOR CONNECTION

4.2.3 Oscillator and Timing

The TMS9918A/9928A/9929A internal timing generation is controlled by a self-contained oscillator and timing circuits. A 10.738635 ($\pm 0.005\%$) MHz fundamental-frequency parallel-mode crystal is used to drive the basic oscillator frequency.

C1 and C2 are load capacitors for the parallel-resonant crystal. C1 and C2 values may be varied slightly to obtain more accuracy in timing and color generation and also to compensate for stray capacitance on the PC board. Typical values for C1 and C2 range between 15 pF and 39 pF. A trimmer capacitor with a value of 5 pF to 50 pF may also be used instead of C1 and adjusted to provide proper colors to the video monitor.

The VDP may also be operated with an external oscillator source. The VDP connections for this external source are shown in Figure 4-5.

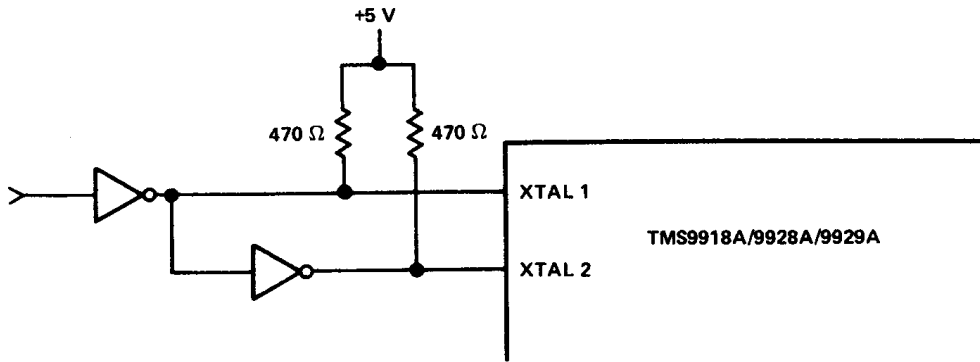

FIGURE 4-5 – EXTERNAL FREQUENCY SOURCE

There may be a slight color shift or a complete color loss in applications of RF modulators if there are mismatches in voltages levels or impedances between the VDP and the RF modulator. See Figure 3-4 for the TMS9928A/9929A interface.

4.2.4 VRAM Connections

The VRAM used in Figure 4-2 are 4116-type dynamic RAMs that meet the specifications in Section 5.

Addressing of the VRAM is done through the address bus and the memory control lines, AD1-AD7 and RAS, CAS, and WR, respectively.

Data written to the VRAM is also sent over the address bus. AD0 is a MSB, and AD7 is the LSB. Data written from the VRAM is brought into the VDP via the read data bus, RD0-RD7. The TMS9918A automatically refreshes the VRAM with no interaction necessary from the host CPU.

Note that address 0 (AD0) and data 0 (D0) are the MSBs for the TMS9918A and all other TMS9900 family members. The VRAM pin designations (A0 and D0) referenced in the data manual are shown as being the LSBs to be consistent with 4116-type dynamic RAM data sheets.

4.3 VDP INITIALIZATION

After powerup and proper reset timing, the VRAM allocation backdrop color and type of dynamic RAM need to be loaded into the VDP registers.

The values to be loaded can be calculated by using the examples and tables shown in Appendix A. The following flowchart (Figure 4-6) shows a procedure for loading all eight VDP registers. Setting 4.4 contains a typical TMS9900 software program designed to work on the demo board, shown in Figure 4-3.

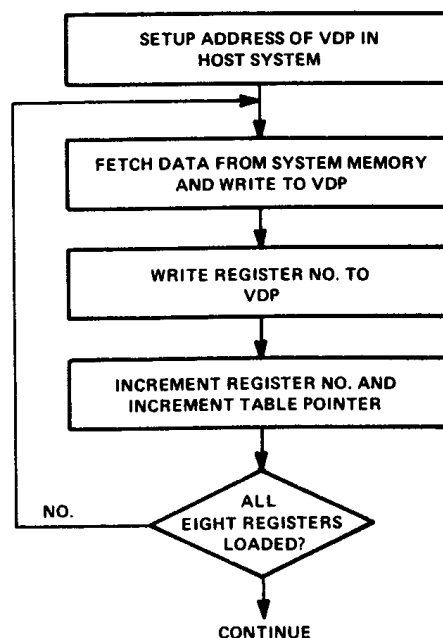

FIGURE 4-6 – VDP REGISTER INITIALIZATION PROCEDURE

4.4 TYPICAL SOFTWARE PROGRAM

4.4.1 General

This program initializes the TMS9918A and loads the Pattern Generator with the upper case character set. It then loads the color table, clears the screen and prints a sign-on message. After initialization, a user program address can be inserted at location 00A4.

DEMO9918 SDSMAC 3.4.0 81.117 15:45:22 MONDAY, SEP 27, 1982.

PAGE 0002

```

0001          IDT 'DEMO9918'
0002 0000          AORG >0000
0003          9000 VRAMW EQU >9000 ADDRESS TO WRITE DATA TO VRAM
0004          9002 VDPW  EQU >9002 ADDRESS TO WRITE DATA TO VDP
0005          9004 VRAMR EQU >9004 ADDRESS TO READ DATA FROM VRAM
0006          9006 VDPR  EQU >9006 ADDRESS TO READ VDP STATUS REGISTER
0007          *
0008          *****
0009          *          INITIALIZE THE 9918 WITH THE FOLLOWING:
0010          *
0011          *          REG 0 = 00  EXT VID OFF, GRAPH 2 OFF
0012          *
0013          *          REG 1 = 02  4116, INT DIS, VID ON, GRAPH 1
0014          *          SIZE 1, MAG OFF
0015          *
0016          *          REG 2 = 01  NAME TABLE SUB BLOCK      @>400
0017          *
0018          *          REG 3 = 08  COLOR TABLE SUB BLOCK      @>200
0019          *
0020          *          REG 4 = 01  PATTERN GEN SUB BLOCK      @>800
0021          *
0022          *          REG 5 = 06  SPRITE NAME TAB SUB BLK    @>300
0023          *
0024          *          REG 6 = 00  SPRITE PATT GEN SUB BLK    @>000
0025          *
0026          *          REG 7 = 07  BACKDROP COLOR IS CYAN
0027          *
0028          *****
0029          *
0030          *
0031          *          NOTE
0032          *          THIS SOFTWARE ASSUMES THAT THE DATA BUS OF THE
0033          *          TMS9918A IS CONNECTED TO THE LEAST SIGNIFICANT
0034          *          BYTE OF THE TMS9900, WITH D7 AS THE MOST
0035          *          SIGNIFICANT BIT AND D15 AS THE LEAST SIGNIFICANT
0036          *          BIT
0037          *
0038          *
0039 0000 0201  INIT  LI  R1,VDPW          VDP WRITE ADDRESS
0002 9002
0040 0004 0202          LI  R2,SUTA          "SET UP TABLE" ADDRESS
0006 00B8
0041 0008 0203          LI  R3,>80          ADDRESS OF FIRST VDP REGISTER
000A 0080
0042 000C C472  LP01  MOV  *R2+,*R1          GET DATA FROM MEM, SEND TO 9918
0043 000E C443          MOV  R3,*R1          SEND REG# TO 9918
0044 0010 0583          INC  R3          INCREMENT REGISTER COUNT
0045 0012 0283          CI   R3,>88          ALL REGS LOADED?
0014 0088
0046 0016 16FA          JNE  LP01          NO,GO AGAIN
0047          *
0048          *
0049          *          LOAD PROGRAM LOADS THE TEXT PATTERNS FROM
0050          *          A TABLE IN MEMORY TO THE PATTERN GENERATOR
0051          *          SUB-BLOCK IN VRAM.
0052          *          ASCII >20 TO >5F ARE INCLUDED IN THIS TABLE.
0053          *
0054          *
0055 0018 0201  LPG1  LI  R1,VRAMW          ADDRESS TO WRITE DATA TO VRAM
001A 9000

```

```

0056 001C 0202          LI  R2,VDPW          ADDRESS TO WRITE TO VDP
      001E 9002
0057 0020 0203          LI  R3,PATT          MEM ADDR OF PATTERNS
      0022 00C0
0058 0024 0204          LI  R4,512          64 CHAR X 8 BYTES - 512 BYTES
      0026 0200
0059 0028 0205          LI  R5,>4900        ADDRESS TO LOAD PATS IN VRAM
      002A 4900
0060 002C C485          MOV  R5,*R2          SEND LSB OF VRAM ADDRESS TO VDP
0061 002E 06C5          SWPB R5            REVERSE BYTES
0062 0030 C445          MOV  R5,*R1          SEND DATA TO VRAM
0063 0032 D173          LPGA2 MOVB *R3+,R5    GET BYTE FROM MEM
0064 0034 06C5          SWPB R5            REVERSE BYTES
0065 0036 C445          MOV  R5,*R1          SEND DATA TO VRAM
0066 0038 0604          DEC  R4            ALL DONE YET?
0067 003A 16FB          JNE  LPG2          NO, GO AGAIN
0068          *
0069          *****
0070          *
0071          *              LOAD COLOR TABLE
0072          *
0073          *              THIS ROUTINE LOADS THE COLOR TABLE FOR THE
0074          *              TEXT PATTERNS JUST ENTERED.
0075          *
0076 003C 0201          LI  R1,VRAMW        ADDRESS TO WRITE DATA TO VRAM
      003E 9000
0077 0040 0202          LI  R2,VDPW        ADDRESS TO WRITE TO VDP
      0042 9002
0078 0044 0203          LI  R3,>4204        START ADDRESS OF TEXT COLOR TABL
      0046 4204
0079 0048 0204          LI  R4,>5F          CHARACTERS WILL BE BLUE ON WHITE
      004A 005F
0080 004C C483          MOV  R3,*R2        SEND LSB OF VRAM ADDRESS TO VDP
0081 004E 0205          LI  R5,8           LOAD COUNT VALUE, 64CHAR/8 = 8
      0050 0008
0082 0052 C444          LCTL MOV  R4,*R1        SEND COLOR INFO TO VRAM
0083 0054 0605          DEC  R5           TABLE LAODED YET?
0084 0056 16FD          JNE  LCTL          NO, GO AGAIN
0085          *
0086          *****
0087          *
0088          *              CLEAR SCREEN
0089          *
0090          *              THIS ROUTINE CLEARS THE SCREEN BY WRITING A SPACE
0091          *              CHARACTER (ASCII >20) TO ALL LOCATIONS IN THE
0092          *              NAME TABLE.
0093          *
0094 0058 0201          LI  R1,VRAMW        ADDRESS TO WRITE DATA TO VRAM
      005A 9000
0095 005C 0202          LI  R2,VDPW        ADDRESS TO WRITE TO VDP
      005E 9002
0096 0060 0203          LI  R3,>4400        START ADDRESS IN NAME TABLE
      0062 4400
0097 0064 C483          MOV  R3,*R2        SEND MSB OF VRAM ADDRESS TO VDP
0098 0066 0202          LI  R2,768        #OF POSITIONS ON SCREEN
      0068 0300
0099 006A 0203          LI  R3,>20         ASCII SPACE CHAR
      006C 0020
0100 006E C443          CSL1 MOV  R3,*R1        SEND SPACE TO SCREEN
0101 0070 0602          DEC  R2           ARE ALL LOCATIONS CLEAR?

```

```

0102 0072 16FD          JNE  CSL1          NO, GO AGAIN
0103                   *
0104                   *****
0105                   *
0106                   *          PRINT SIGN ON MESSAGE
0107                   *          AND BRANCH TO USERS PROGRAM
0108                   *
0109 0074 0201          LI   R1,VRAMW        ADDRESS TO WRITE DATA TO VRAM
      0076 9000
0110 0078 0202          LI   R2,VDPW        ADDRESS TO WRITE TO VDP
      007A 9002
0111 007C 0203          LI   R3,>4400       POSITION OF MESSAGE ON SCREEN
      007E 4400
0112 0080 C483          MOV  R3,*R2        SEND MSB OF VRAM ADDRESS TO VDP
0113 0082 06C3          SWPB R3          REVERSE BYTES
0114 0084 C483          MOV  R3,*R2        SEND MSB OF VRAM ADDRESS TO VDP
0115 0086 0203          LI   R3,MSG0       ADDRESS OF SIGN ON MESSAGE
      0088 009E
0116 008A 04C4          PRNT  CLR  R4          CLEAR RECEPTION REGISTER
0117 008C D113          MOVB *R3,R4       GET A BYTE OF TEXT
0118 008E 0284          CI   R4,>FF00       IS IT THE EOM CHARACTER?
      0090 FF00
0119 0092 1303          JEQ  DONE        YES, GOTO NEXT PROGRAM SEGMENT
0120 0094 06C4          SWPB R4          REVERSE BYTES
0121 0096 C444          MOV  R4,*R1        SEND CHAR TO VRAM
0122 0098 10F8          JMP  PRNT        GET NEXT CHARACTER
0123 009A 0460          DONE  B    @DONE       INSERT BRANCH TO USERS PROGRAM
      009C 009A
0124                   *
0125 009E 54           MSG0  TEXT 'TEXAS INSTRUMENTS TMS9918'
      009F 45
      00A0 58
      00A1 41
      00A2 53
      00A3 20
      00A4 49
      00A5 4E
      00A6 53
      00A7 54
      00A8 52
      00A9 55
      00AA 4D
      00AB 45
      00AC 4E
      00AD 54
      00AE 53
      00AF 20
      00B0 54
      00B1 4D
      00B2 53
      00B3 39
      00B4 39
      00B5 31
      00B6 38
0126 00B7 FF           BYTE >FF
0127 00B8             EVEN
0128                   *
0129                   *****
0130                   *
0131                   *          THIS TABLE CONTAINS THE VALUES FOR
                                INITIALIZING THE REGISTERS IN THE 9918A

```

```

0132          *
0133 00B8 00 SUTA  BYTE >00
0134 00B9 02      BYTE >02
0135 00BA 01      BYTE >01
0136 00BB 08      BYTE >08
0137 00BC 01      BYTE >01
0138 00BD 06      BYTE >06
0139 00BE 00      BYTE >00
0140 00BF 07      BYTE >07
0141          *
0142          *****
0143          *
0144          *
0145          *
0146          *
0147          *
0148          *
0149 00C0 0000 PATT  DATA >0000          CHARACTER SPACE ASCII 20
0150 00C2 0000          DATA >0000
0151 00C4 0000          DATA >0000
0152 00C6 0000          DATA >0000
0153 00C8 2020          DATA >2020          CHARACTER !      ASCII 21
0154 00CA 2020          DATA >2020
0155 00CC 2000          DATA >2000
0156 00CE 2000          DATA >2000
0157 00D0 5050          DATA >5050          CHARACTER "      ASCII 22
0158 00D2 5000          DATA >5000
0159 00D4 0000          DATA >0000
0160 00D6 0000          DATA >0000
0161 00D8 5050          DATA >5050          CHARACTER #      ASCII 23
0162 00DA F850          DATA >F850
0163 00DC F850          DATA >F850
0164 00DE 5000          DATA >5000
0165 00E0 2078          DATA >2078          CHARACTER $      ASCII 24
0166 00E2 A070          DATA >A070
0167 00E4 28F0          DATA >28F0
0168 00E6 2000          DATA >2000
0169 00E8 C0C8          DATA >C0C8          CHARACTER %      ASCII 25
0170 00EA 1020          DATA >1020
0171 00EC 4098          DATA >4098
0172 00EE 1800          DATA >1800
0173 00F0 40A0          DATA >40A0          CHARACTER &      ASCII 26
0174 00F2 A040          DATA >A040
0175 00F4 A890          DATA >A890
0176 00F6 6800          DATA >6800
0177 00F8 2020          DATA >2020          CHARACTER '      ASCII 27
0178 00FA 2000          DATA >2000
0179 00FC 0000          DATA >0000
0180 00FE 0000          DATA >0000
0181 0100 2040          DATA >2040          CHARACTER (      ASCII 28
0182 0102 8080          DATA >8080
0183 0104 8040          DATA >8040
0184 0106 2000          DATA >2000
0185 0108 2010          DATA >2010          CHARACTER )      ASCII 29
0186 010A 0808          DATA >0808
0187 010C 0810          DATA >0810
0188 010E 2000          DATA >2000
0189 0110 20A8          DATA >20A8          CHARACTER *      ASCII 2A
0190 0112 7020          DATA >7020
0191 0114 70A8          DATA >70A8
    
```

0192	0116	2000	DATA	>2000		
0193	0118	0020	DATA	>0020	CHARACTER +	ASCII 2B
0194	011A	20F8	DATA	>20F8		
0195	011C	2020	DATA	>2020		
0196	011E	0000	DATA	>0000		
0197	0120	0000	DATA	>0000	CHARACTER ,	ASCII 2C
0198	0122	0000	DATA	>0000		
0199	0124	2020	DATA	>2020		
0200	0126	4000	DATA	>4000		
0201	0128	0000	DATA	>0000	CHARACTER -	ASCII 2D
0202	012A	00F8	DATA	>00F8		
0203	012C	0000	DATA	>0000		
0204	012E	0000	DATA	>0000		
0205	0130	0000	DATA	>0000	CHARACTER .	ASCII 2E
0206	0132	0000	DATA	>0000		
0207	0134	0000	DATA	>0000		
0208	0136	2000	DATA	>2000		
0209	0138	0008	DATA	>0008	CHARACTER /	ASCII 2F
0210	013A	1020	DATA	>1020		
0211	013C	4080	DATA	>4080		
0212	013E	0000	DATA	>0000		
0213	0140	7088	DATA	>7088	CHARACTER 0	ASCII 30
0214	0142	98A8	DATA	>98A8		
0215	0144	C888	DATA	>C888		
0216	0146	7000	DATA	>7000		
0217	0148	2060	DATA	>2060	CHARACTER 1	ASCII 31
0218	014A	2020	DATA	>2020		
0219	014C	2020	DATA	>2020		
0220	014E	7000	DATA	>7000		
0221	0150	7088	DATA	>7088	CHARACTER 2	ASCII 32
0222	0152	0830	DATA	>0830		
0223	0154	4080	DATA	>4080		
0224	0156	F800	DATA	>F800		
0225	0158	F808	DATA	>F808	CHARACTER 3	ASCII 33
0226	015A	1030	DATA	>1030		
0227	015C	0888	DATA	>0888		
0228	015E	7000	DATA	>7000		
0229	0160	1030	DATA	>1030	CHARACTER 4	ASCII 34
0230	0162	5090	DATA	>5090		
0231	0164	F810	DATA	>F810		
0232	0166	1000	DATA	>1000		
0233	0168	F880	DATA	>F880	CHARACTER 5	ASCII 35
0234	016A	F008	DATA	>F008		
0235	016C	0888	DATA	>0888		
0236	016E	7000	DATA	>7000		
0237	0170	3840	DATA	>3840	CHARACTER 6	ASCII 36
0238	0172	80F0	DATA	>80F0		
0239	0174	8888	DATA	>8888		
0240	0176	7000	DATA	>7000		
0241	0178	F808	DATA	>F808	CHARACTER 7	ASCII 37
0242	017A	1020	DATA	>1020		
0243	017C	4040	DATA	>4040		
0244	017E	4000	DATA	>4000		
0245	0180	7088	DATA	>7088	CHARACTER 8	ASCII 38
0246	0182	8870	DATA	>8870		
0247	0184	8888	DATA	>8888		
0248	0186	7000	DATA	>7000		
0249	0188	7088	DATA	>7088	CHARACTER 9	ASCII 39
0250	018A	8878	DATA	>8878		
0251	018C	0810	DATA	>0810		

0252	018E	E000	DATA >E000		
0253	0190	0000	DATA >0000	CHARACTER :	ASCII 3A
0254	0192	2000	DATA >2000		
0255	0194	2000	DATA >2000		
0256	0196	0000	DATA >0000		
0257	0198	0000	DATA >0000	CHARACTER ;	ASCII 3B
0258	019A	2000	DATA >2000		
0259	019C	2020	DATA >2020		
0260	019E	4000	DATA >4000		
0261	01A0	1020	DATA >1020	CHARACTER <	ASCII 3C
0262	01A2	4080	DATA >4080		
0263	01A4	4020	DATA >4020		
0264	01A6	1000	DATA >1000		
0265	01A8	0000	DATA >0000	CHARACTER =	ASCII 3D
0266	01AA	F800	DATA >F800		
0267	01AC	F800	DATA >F800		
0268	01AE	0000	DATA >0000		
0269	01B0	4020	DATA >4020	CHARACTER >	ASCII 3E
0270	01B2	1008	DATA >1008		
0271	01B4	1020	DATA >1020		
0272	01B6	4000	DATA >4000		
0273	01B8	7088	DATA >7088	CHARACTER ?	ASCII 3F
0274	01BA	1020	DATA >1020		
0275	01BC	2000	DATA >2000		
0276	01BE	2000	DATA >2000		
0277	01C0	7088	DATA >7088	CHARACTER @	ASCII 40
0278	01C2	A8B8	DATA >A8B8		
0279	01C4	B080	DATA >B080		
0280	01C6	7800	DATA >7800		
0281	01C8	2050	DATA >2050	CHARACTER A	ASCII 41
0282	01CA	8888	DATA >8888		
0283	01CC	F888	DATA >F888		
0284	01CE	8800	DATA >8800		
0285	01D0	F088	DATA >F088	CHARACTER B	ASCII 42
0286	01D2	88F0	DATA >88F0		
0287	01D4	8888	DATA >8888		
0288	01D6	F000	DATA >F000		
0289	01D8	7088	DATA >7088	CHARACTER C	ASCII 43
0290	01DA	8080	DATA >8080		
0291	01DC	8088	DATA >8088		
0292	01DE	7000	DATA >7000		
0293	01E0	F088	DATA >F088	CHARACTER D	ASCII 44
0294	01E2	8888	DATA >8888		
0295	01E4	8888	DATA >8888		
0296	01E6	F000	DATA >F000		
0297	01E8	F880	DATA >F880	CHARACTER E	ASCII 45
0298	01EA	80F0	DATA >80F0		
0299	01EC	8080	DATA >8080		
0300	01EE	F800	DATA >F800		
0301	01F0	F880	DATA >F880	CHARACTER F	ASCII 46
0302	01F2	80F0	DATA >80F0		
0303	01F4	8080	DATA >8080		
0304	01F6	8000	DATA >8000		
0305	01F8	7880	DATA >7880	CHARACTER G	ASCII 47
0306	01FA	8080	DATA >8080		
0307	01FC	9888	DATA >9888		
0308	01FE	7800	DATA >7800		
0309	0200	8888	DATA >8888	CHARACTER H	ASCII 48
0310	0202	88F8	DATA >88F8		
0311	0204	8888	DATA >8888		

0312	0206	8800	DATA	>8800		
0313	0208	7020	DATA	>7020	CHARACTER I	ASCII 49
0314	020A	2020	DATA	>2020		
0315	020C	2020	DATA	>2020		
0316	020E	7000	DATA	>7000		
0317	0210	0808	DATA	>0808	CHARACTER J	ASCII 4A
0318	0212	0808	DATA	>0808		
0319	0214	0888	DATA	>0888		
0320	0216	7000	DATA	>7000		
0321	0218	8890	DATA	>8890	CHARACTER K	ASCII 4B
0322	021A	A0C0	DATA	>A0C0		
0323	021C	A090	DATA	>A090		
0324	021E	8800	DATA	>8800		
0325	0220	8080	DATA	>8080	CHARACTER L	ASCII 4C
0326	0222	8080	DATA	>8080		
0327	0224	8080	DATA	>8080		
0328	0226	F800	DATA	>F800		
0329	0228	88D8	DATA	>88D8	CHARACTER M	ASCII 4D
0330	022A	A8A8	DATA	>A8A8		
0331	022C	8888	DATA	>8888		
0332	022E	8800	DATA	>8800		
0333	0230	8888	DATA	>8888	CHARACTER N	ASCII 4E
0334	0232	C8A8	DATA	>C8A8		
0335	0234	9888	DATA	>9888		
0336	0236	8800	DATA	>8800		
0337	0238	7088	DATA	>7088	CHARACTER O	ASCII 4F
0338	023A	8888	DATA	>8888		
0339	023C	8888	DATA	>8888		
0340	023E	7000	DATA	>7000		
0341	0240	F088	DATA	>F088	CHARACTER P	ASCII 50
0342	0242	88F0	DATA	>88F0		
0343	0244	8080	DATA	>8080		
0344	0246	8000	DATA	>8000		
0345	0248	7088	DATA	>7088	CHARACTER Q	ASCII 51
0346	024A	8888	DATA	>8888		
0347	024C	A890	DATA	>A890		
0348	024E	6800	DATA	>6800		
0349	0250	F088	DATA	>F088	CHARACTER R	ASCII 52
0350	0252	88F0	DATA	>88F0		
0351	0254	A090	DATA	>A090		
0352	0256	8800	DATA	>8800		
0353	0258	7088	DATA	>7088	CHARACTER S	ASCII 53
0354	025A	8070	DATA	>8070		
0355	025C	0888	DATA	>0888		
0356	025E	7000	DATA	>7000		
0357	0260	F820	DATA	>F820	CHARACTER T	ASCII 54
0358	0262	2020	DATA	>2020		
0359	0264	2020	DATA	>2020		
0360	0266	2000	DATA	>2000		
0361	0268	8888	DATA	>8888	CHARACTER U	ASCII 55
0362	026A	8888	DATA	>8888		
0363	026C	8888	DATA	>8888		
0364	026E	7000	DATA	>7000		
0365	0270	8888	DATA	>8888	CHARACTER V	ASCII 56
0366	0272	8888	DATA	>8888		
0367	0274	8850	DATA	>8850		
0368	0276	2000	DATA	>2000		
0369	0278	8888	DATA	>8888	CHARACTER W	ASCII 57
0370	027A	88A8	DATA	>88A8		
0371	027C	A8D8	DATA	>A8D8		

0372	027E	8800	DATA	>8800		
0373	0280	8888	DATA	>8888	CHARACTER X	ASCII 58
0374	0282	5020	DATA	>5020		
0375	0284	5088	DATA	>5088		
0376	0286	8800	DATA	>8800		
0377	0288	8888	DATA	>8888	CHARACTER Y	ASCII 59
0378	028A	5020	DATA	>5020		
0379	028C	2020	DATA	>2020		
0380	028E	2000	DATA	>2000		
0381	0290	F808	DATA	>F808	CHARACTER Z	ASCII 5A
0382	0292	1020	DATA	>1020		
0383	0294	4080	DATA	>4080		
0384	0296	F800	DATA	>F800		
0385	0298	F8C0	DATA	>F8C0	CHARACTER [ASCII 5B
0386	029A	C0C0	DATA	>C0C0		
0387	029C	C0C0	DATA	>C0C0		
0388	029E	F800	DATA	>F800		
0389	02A0	0080	DATA	>0080	CHARACTER	ASCII 5C
0390	02A2	4020	DATA	>4020		
0391	02A4	1008	DATA	>1008		
0392	02A6	0000	DATA	>0000		
0393	02A8	F818	DATA	>F818	CHARACTER]	ASCII 5D
0394	02AA	1818	DATA	>1818		
0395	02AC	1818	DATA	>1818		
0396	02AE	F800	DATA	>F800		
0397	02B0	0000	DATA	>0000	CHARACTER	ASCII 5E
0398	02B2	2050	DATA	>2050		
0399	02B4	8800	DATA	>8800		
0400	02B6	0000	DATA	>0000		
0401	02B8	0000	DATA	>0000	CHARACTER _	ASCII 5F
0402	02BA	0000	DATA	>0000		
0403	02BC	0000	DATA	>0000		
0404	02BE	F800	DATA	>F800		
0405	02C0	4020	DATA	>4020	CHARACTER	ASCII 60
0406	02C2	1000	DATA	>1000		
0407	02C4	0000	DATA	>0000		
0408	02C6	0000	DATA	>0000		
0409	02C8	0000	DATA	>0000	CHARACTER a	ASCII 61
0410	02CA	7088	DATA	>7088		
0411	02CC	F888	DATA	>F888		
0412	02CE	8800	DATA	>8800		
0413	02D0	0000	DATA	>0000	CHARACTER b	ASCII 62
0414	02D2	F048	DATA	>F048		
0415	02D4	7048	DATA	>7048		
0416	02D6	F000	DATA	>F000		
0417	02D8	0000	DATA	>0000	CHARACTER c	ASCII 63
0418	02DA	7880	DATA	>7880		
0419	02DC	8080	DATA	>8080		
0420	02DE	7800	DATA	>7800		
0421	02E0	0000	DATA	>0000	CHARACTER d	ASCII 64
0422	02E2	F048	DATA	>F048		
0423	02E4	4848	DATA	>4848		
0424	02E6	F000	DATA	>F000		
0425	02E8	0000	DATA	>0000	CHARACTER e	ASCII 65
0426	02EA	F080	DATA	>F080		
0427	02EC	E080	DATA	>E080		
0428	02EE	F000	DATA	>F000		
0429	02F0	0000	DATA	>0000	CHARACTER f	ASCII 66
0430	02F2	F080	DATA	>F080		
0431	02F4	E080	DATA	>E080		

0432	02F6	8000	DATA	>8000		
0433	02F8	0000	DATA	>0000	CHARACTER	g ASCII 67
0434	02FA	7880	DATA	>7880		
0435	02FC	B888	DATA	>B888		
0436	02FE	7000	DATA	>7000		
0437	0300	0000	DATA	>0000	CHARACTER	h ASCII 68
0438	0302	8888	DATA	>8888		
0439	0304	F888	DATA	>F888		
0440	0306	8800	DATA	>8800		
0441	0308	0000	DATA	>0000	CHARACTER	i ASCII 69
0442	030A	F820	DATA	>F820		
0443	030C	2020	DATA	>2020		
0444	030E	F800	DATA	>F800		
0445	0310	0000	DATA	>0000	CHARACTER	j ASCII 6A
0446	0312	7020	DATA	>7020		
0447	0314	20A0	DATA	>20A0		
0448	0316	E000	DATA	>E000		
0449	0318	0000	DATA	>0000	CHARACTER	k ASCII 6B
0450	031A	90A0	DATA	>90A0		
0451	031C	A0C0	DATA	>A0C0		
0452	031E	9000	DATA	>9000		
0453	0320	0000	DATA	>0000	CHARACTER	l ASCII 6C
0454	0322	8080	DATA	>8080		
0455	0324	8080	DATA	>8080		
0456	0326	F800	DATA	>F800		
0457	0328	0000	DATA	>0000	CHARACTER	m ASCII 6D
0458	032A	88D8	DATA	>88D8		
0459	032C	A888	DATA	>A888		
0460	032E	8800	DATA	>8800		
0461	0330	0000	DATA	>0000	CHARACTER	n ASCII 6E
0462	0332	88C8	DATA	>88C8		
0463	0334	A898	DATA	>A898		
0464	0336	8800	DATA	>8800		
0465	0338	0000	DATA	>0000	CHARACTER	o ASCII 6F
0466	033A	F888	DATA	>F888		
0467	033C	8888	DATA	>8888		
0468	033E	F800	DATA	>F800		
0469	0340	0000	DATA	>0000	CHARACTER	p ASCII 70
0470	0342	F088	DATA	>F088		
0471	0344	F080	DATA	>F080		
0472	0346	8000	DATA	>8000		
0473	0348	0000	DATA	>0000	CHARACTER	q ASCII 71
0474	034A	F888	DATA	>F888		
0475	034C	A890	DATA	>A890		
0476	034E	E000	DATA	>E000		
0477	0350	0000	DATA	>0000	CHARACTER	r ASCII 72
0478	0352	F888	DATA	>F888		
0479	0354	F8A0	DATA	>F8A0		
0480	0356	9000	DATA	>9000		
0481	0358	0000	DATA	>0000	CHARACTER	s ASCII 73
0482	035A	7880	DATA	>7880		
0483	035C	7008	DATA	>7008		
0484	035E	F000	DATA	>F000		
0485	0360	0000	DATA	>0000	CHARACTER	t ASCII 74
0486	0362	F820	DATA	>F820		
0487	0364	2020	DATA	>2020		
0488	0366	2000	DATA	>2000		
0489	0368	0000	DATA	>0000	CHARACTER	u ASCII 75
0490	036A	8888	DATA	>8888		
0491	036C	8888	DATA	>8888		

0492	036E	7000	DATA	>7000		
0493	0370	0000	DATA	>0000	CHARACTER	v ASCII 76
0494	0372	8888	DATA	>8888		
0495	0374	90A0	DATA	>90A0		
0496	0376	4000	DATA	>4000		
0497	0378	0000	DATA	>0000	CHARACTER	w ASCII 77
0498	037A	8888	DATA	>8888		
0499	037C	A8D8	DATA	>A8D8		
0500	037E	8800	DATA	>8800		
0501	0380	0000	DATA	>0000	CHARACTER	x ASCII 78
0502	0382	8860	DATA	>8860		
0503	0384	2060	DATA	>2060		
0504	0386	8800	DATA	>8800		
0505	0388	0000	DATA	>0000	CHARACTER	y ASCII 79
0506	038A	8850	DATA	>8850		
0507	038C	2020	DATA	>2020		
0508	038E	2000	DATA	>2000		
0509	0390	0000	DATA	>0000	CHARACTER	z ASCII 7A
0510	0392	F810	DATA	>F810		
0511	0394	2040	DATA	>2040		
0512	0396	F800	DATA	>F800		
0513	0398	3840	DATA	>3840	CHARACTER	ASCII 7B
0514	039A	20C0	DATA	>20C0		
0515	039C	2040	DATA	>2040		
0516	039E	3800	DATA	>3800		
0517	03A0	4020	DATA	>4020	CHARACTER	ASCII 7C
0518	03A2	1008	DATA	>1008		
0519	03A4	1020	DATA	>1020		
0520	03A6	4000	DATA	>4000		
0521	03A8	E010	DATA	>E010	CHARACTER	ASCII 7D
0522	03AA	2018	DATA	>2018		
0523	03AC	2010	DATA	>2010		
0524	03AE	E000	DATA	>E000		
0525	03B0	40A8	DATA	>40A8	CHARACTER	ASCII 7E
0526	03B2	1000	DATA	>1000		
0527	03B4	0000	DATA	>0000		
0528	03B6	0000	DATA	>0000		
0529	03B8	A850	DATA	>A850	CHARACTER	ASCII 7F
0530	03BA	A850	DATA	>A850		
0531	03BC	A850	DATA	>A850		
0532	03BE	A800	DATA	>A800		
0533			END			

NO ERRORS, NO WARNINGS

4.5 TMS9900 SOFTWARE SUBROUTINES

NOTE: Before using any of the line drawing subroutines, the "Load Line Drawing Patterns" subroutine must be executed.

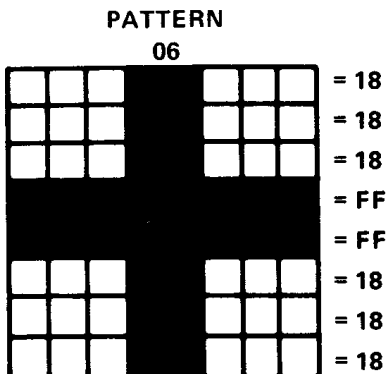
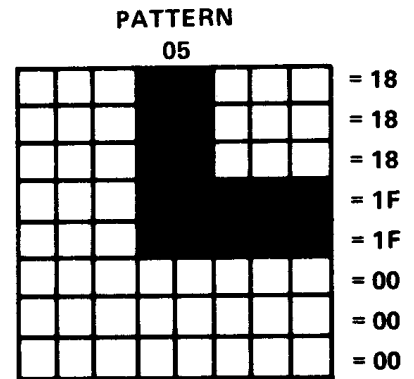
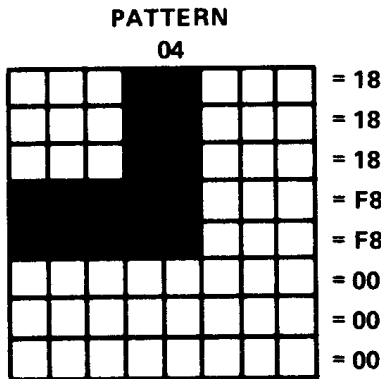
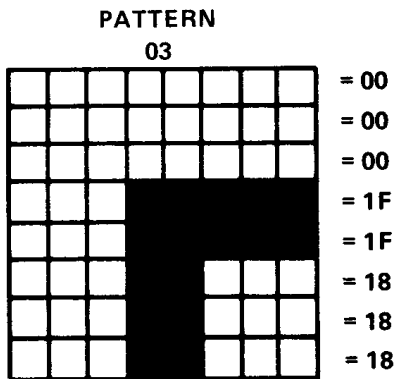
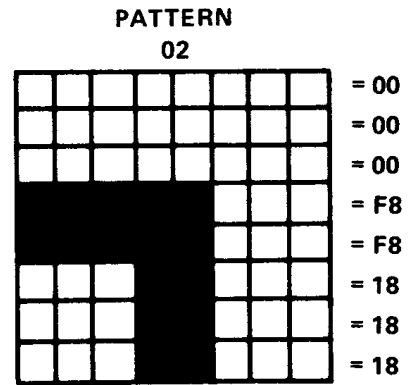
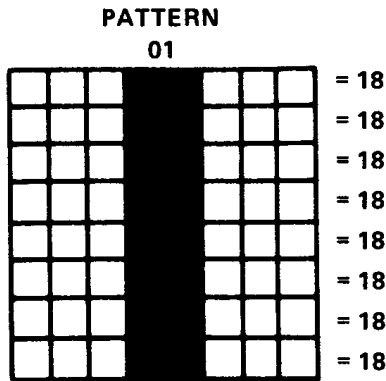
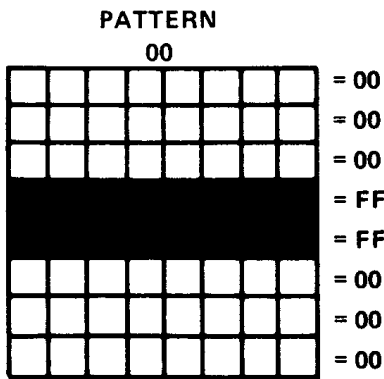

```

0001          IDT 'SEGMENTS'
0002          *****
0003          *
0004          *                                TMS9918A SUBROUTINES                                *
0005          *
0006          *****
0007          9000  VRAMW  EQU  >9000  ADDRESS TO WRITE DATA TO VRAM
0008          9002  VDPW   EQU  >9002  ADDRESS TO WRITE DATA TO VDP
0009          9004  VRAMR  EQU  >9004  ADDRESS TO READ DATA FROM VRAM
0010          9006  VDPR   EQU  >9006  ADDRESS TO READ STATUS FROM VDP
0011          *****
0012          *
0013          *                                LOAD LINE DRAWING PATTERNS                                *
0014          *
0015          *                                REGISTERS USED:
0016          *
0017          *                                REG 1 = RESERVED
0018          *                                REG 2 = RESERVED
0019          *                                REG 3 = ADDRESS OF PATTERN GENERATOR
0020          *                                REG 4 = PATTERN LOCATION IN MEMORY
0021          *                                REG 5 = COLORS OF DRAWING PATTERNS
0022          *                                (USER DEFINED)
0023          *
0024          *
0025          *
0026          0000  0201          LI    R1,VRAMW          ADDRESS TO WRITE DATA TO VRAM
0027          0002  9000
0027          0004  0202          LI    R2,VDPW          ADDRESS TO WRITE TO VDP
0027          0006  9002
0028          0008  0203          LI    R3,>4800        ADDRESS IN PATT GEN FOR PATT 0
0028          000A  4800
0029          000C  0204          LI    R4,PATD          DRAWING PATTERNS LOCATED IN MEM
0029          000E  002E'
0030          0010  C483          NOV   R3,*R2          SEND MSB OF VRAM ADDRESS TO VDP
0031          0012  06C3          SWPB R3          REVERSE BYTES
0032          0014  C483          NOV   R3,*R2          SEND LSB OF VRAM ADDRESS TO VDP
0033          0016  0203          LI    R3,56          7 PATTERNS X 8 BYTES EACH
0033          0018  0038
0034          001A  D474          LLD1  MOVB *R4+,*R1          SEND BYTE TO VRAM
0035          001C  0603          DEC  R3          DECREMENT BYTE COUNT
0036          001E  16FD          JNE  LLD1          IF NOT DONE, GET NEXT BYTE
0037          0020  0203          LI    R3,>4200        ADDRESS OF COLOR TABLE
0037          0022  4200
0038          0024  C483          NOV   R3,*R2          SEND LSB OF VRAM ADDRESS TO VDP
0039          0026  06C3          SWPB R3          REVERSE BYTES
0040          0028  C483          NOV   R3,*R2          SEND MSB OF VRAM ADDRESS TO VDP
0041          002A  C445          NOV   R5,*R1          SEND COLOR BYTE TO VRAM
0042          002C  045B          B    *R11          RETURN TO CALLING PROGRAM
0043          *
0044          *
0045          *                                PATTERNS FOR LINE DRAWING
0046          *
0047          *
0048          002E  0000          PATD  DATA >0000          PATTERN 00
0049          0030  00FF          DATA >00FF
0050          0032  FF00          DATA >FF00
0051          0034  0000          DATA >0000
0052          0036  1818          DATA >1818          PATTERN 01
0053          0038  1818          DATA >1818
0054          003A  1818          DATA >1818
    
```



```

0055 003C 1818      DATA >1818
0056 003E 0000      DATA >0000      PATTERN 02
0057 0040 00F8      DATA >00F8
0058 0042 F818      DATA >F818
0059 0044 1818      DATA >1818
0060 0046 0000      DATA >0000      PATTERN 03
0061 0048 001F      DATA >001F
0062 004A 1F18      DATA >1F18
0063 004C 1818      DATA >1818
0064 004E 1818      DATA >1818      PATTERN 04
0065 0050 18F8      DATA >18F8
0066 0052 F800      DATA >F800
0067 0054 0000      DATA >0000
0068 0056 1818      DATA >1818      PATTERN 05
0069 0058 181F      DATA >181F
0070 005A 1F00      DATA >1F00
0071 005C 0000      DATA >0000
0072 005E 1818      DATA >1818      PATTERN 06
0073 0060 18FF      DATA >18FF
0074 0062 FF18      DATA >FF18
0075 0064 1818      DATA >1818

```

```

0076 *
0077 *
0078 *****
0079 *
0080 *           LOAD SPRITES SUBROUTINE           *
0081 *
0082 *   REGISTERS USED:                           *
0083 *
0084 *   R1 = RESERVED                             *
0085 *   R2 = RESERVED                             *
0086 *   R3 = ADDRESS OF SPRITE TABLE IN VRAM    *
0087 *   R4 = MEMORY ADDRESS OF SPRITE TABLE (USER DEF) *
0088 *   R5 = NUMBER OF BYTES TO TRANSFER (USER DEF) *
0089 *
0090 *****
0091 *
0092 0066 0201      LI    R1,VRAMW      ADDRESS TO WRITE DATA TO VRAM
      0068 9000
0093 006A 0202      LI    R2,VDPW      ADDRESS TO WRITE TO VDP
      006C 9002
0094 006E 0203      LI    R3,>4000    ADDRESS OF SPRITE TABLE IN VRAM
      0070 4000
0095 0072 C483      MOV   R3,*R2      SEND LSB OF VRAM ADDRESS TO VDP
0096 0074 06C3      SWPB  R3      REVERSE BYTES
0097 0076 C483      MOV   R3,*R2      SEND MSB OF VRAM ADDRESS TO VDP
0098 0078 D0F4      LDPL  MOVB *R4+,R3    GET BYTE OF DATA FROM MEM
0099 007A 06C3      SWPB  R3      REVERSE BYTES
0100 007C C443      MOV   R3,*R1      SEND DATA TO VRAM
0101 007E 0605      DEC   R5      ARE WE DONE YET?
0102 0080 16FB      JNE  LDPL      NO, GO AGAIN
0103 0082 045B      B     *R11     YES, RETURN TO CALLING PROGRAM

```

```

0105 *****
0106 *
0107 *          CLEAR SCREEN SUBROUTINE          *
0108 *
0109 *          REGISTERS USED:                    *
0110 *
0111 *          R1 = RESERVED                      *
0112 *          R2 = RESERVED                      *
0113 *          R3 = START ADDRESS ON SCREEN      *
0114 *
0115 *****
0116 *
0117 *
0118 0084 0201 CLSC  LI  R1,VRANW          ADDRESS TO WRITE DATA TO VRAM
      0086 9000
0119 0088 0202          LI  R2,VDPW          ADDRESS TO WRITE TO VDP
      008A 9002
0120 008C 0203          LI  R3,>4400        START LOCATION OF THE NAME TABLE
      008E 4400
0121 0090 C483          MOV  R3,*R2          SEND LSB OF VRAM ADDRESS TO VDP
0122 0092 06C3          SWPB R3            REVERSE BYTES
0123 0094 C483          MOV  R3,*R2          SEND MSB OF VRAM ADDRESS TO VDP
0124 0096 0202          LI  R2,768         #OF POSITIONS ON SCREEN
      0098 0300
0125 009A 0203          LI  R3,>20         ASCII SPACE CHAR
      009C 0020
0126 009E C443 CSL1  MOV  R3,*R1          SEND SPACE CHAR TO VRAM
0127 00A0 0602          DEC  R2            ARE ALL LOCATIONS CLEAR?
0128 00A2 16FD          JNE  CSL1         NO, GO AGAIN
0129 00A4 045B          B    *R11         YES, RETURN TO CALLING PROGRAM
0130 *
0131 *
0132 *****
0133 *
0134 *          PRINT MESSAGE SUBROUTINE          *
0135 *          AND BRANCH TO USERS PROGRAM        *
0136 *
0137 *          REGISTERS USED:                    *
0138 *
0139 *          R1 = RESERVED                      *
0140 *          R2 = RESERVED                      *
0141 *          R3 = STARTING ADDRESS OF MESSAGE  *
0142 *          TABLE (USER DEFINED)            *
0143 *          R4 = MEMORY ADDRESS OF MESSAGE   *
0144 *          (USER DEFINED)                    *
0145 *          NOTE:  END MESSAGE STRING WITH   *
0146 *          A BYTE 00                          *
0147 *****
0148 *
0149 *
0150 00A6 0201 PRNT  LI  R1,VRANW          ADDRESS TO WRITE DATA TO VRAM
      00A8 9000
0151 00AA 0202          LI  R2,VDPW          ADDRESS TO WRITE TO VDP
      00AC 9002
0152 00AE C483          MOV  R3,*R2          SEND LSB OF VRAM ADDRESS TO VDP
0153 00B0 06C3          SWPB R3            REVERSE BYTES
0154 00B2 C483          MOV  R3,*R2          SEND MSB OF VRAM ADDRESS TO VDP
0155 00B4 D0B4 PRL1  MOVB *R4+,R2        GET BYTE OF TEXT FROM MEM
0156 00B6 1303          JEQ  PRL2         IF ZERO, THEN END OF MESS
0157 00B8 06C2          SWPB R2            INDEX BYTE INTO POSITION

```

```

0158 00BA C442          MOV R2,*R1          SEND CHAR TO VRAM
0159 00BC 10FB          JMP PRL1           GET NEXT CHAR
0160 00BE 045B PRL2    B *R11           RETURN TO CALLING PROGRAM
0161 *
0162 *
0163 *****
0164 *
0165 *           ERASE TO END OF SCREEN SUBROUTINE           *
0166 *
0167 *           REGISTERS USED:                               *
0168 *
0169 *           R1 = RESERVED                                  *
0170 *           R2 = RESERVED                                  *
0171 *           R3 = ADDRESS IN NAME TABLE TO START ERASURE *
0172 *           (USER DEFINED), R3 MUST BE EQUAL TO         *
0173 *           OR GREATER THAN >4400, AND MUST BE LESS     *
0174 *           THAN OR EQUAL TO >46FF                        *
0175 *
0176 *****
0177 *
0178 00C0 0201 EEOS    LI R1,VRAMW          ADDRESS TO WRITE DATA TO VRAM
      00C2 9000
0179 00C4 0202          LI R2,VDPW           ADDRESS TO WRITE TO VDP
      00C6 9002
0180 00C8 C483          MOV R3,*R2          SEND LSB OF VRAM ADDRESS TO VDP
0181 00CA 06C3          SWPB R3           REVERSE BYTES
0182 00CC C483          MOV R3,*R2          SEND MSB OF VRAM ADDRESS TO VDP
0183 00CE 0202          LI R2,>20          LOAD R2 WITH 'SPACE' CHAR
      00D0 0020
0184 00D2 C442 EES1    MOV R2,*R1          SEND 'SPACE' TO SCREEN
0185 00D4 0583          INC R3           INCREMENT CHAR COUNT
0186 00D6 0283          CI R3,>4700        ARE WE AT THE END OF SCREEN
      00D8 4700
0187 00DA 1AFB          JL EES1           IF NOT GO AGAIN
0188 00DC 045B          B *R11           YES, RETURN TO CALLING PROGRAM
0189 *
0190 *
0191 *****
0192 *
0193 *           ERASE LINE SUB                               *
0194 *
0195 *           REGISTERS USED:                               *
0196 *
0197 *           R1 = RESERVED                                  *
0198 *           R2 = RESERVED                                  *
0199 *           R3 = STARTING ADDRESS IN LINE IN NAME        *
0200 *           TABLE TO BE ERASED (USER DEFINED)          *
0201 *****
0202 *
0203 *
0204 00DE 0201 ERLN    LI R1,VRAMW          ADDRESS TO WRITE DATA TO VRAM
      00E0 9000
0205 00E2 0202          LI R2,VDPW           ADDRESS TO WRITE TO VDP
      00E4 9002
0206 00E6 C483          MOV R3,*R2          SEND LSB OF VRAM ADDRESS TO VDP
0207 00E8 06C3          SWPB R3           REVERSE BYTES
0208 00EA C483          MOV R3,*R2          SEND MSB OF VRAM ADDRESS TO VDP
0209 00EC 0202          LI R2,>20          LOAD R2 WITH 'SPACE' CHAR
      00EE 0020
0210 00F0 0203          LI R3,32          LOAD R3 WITH # OF POSTIONS

```

```

00F2 0020
0211 00F4 C442 ERL1 MOV R2,*R1 SEND 'SPACE' CAHR TO NAME TABLE
0212 00F6 0603 DEC R3 DECREMENT CHAR COUNT
0213 00F8 16FD JNE ERL1 IF NOT DONE, GO AGAIN
0214 00FA 045B B *R1 DOME, RETURN TO CALLING PROG
0215 *
0216 *
0217 *****
0218 *
0219 * DRAW A HORIZ LINE *
0220 *
0221 * REGISTERS USED: *
0222 *
0223 * R3 = ADDRESS OF UPPER LEFT CORNER *
0224 * R4 = # OF HORIZ POSITIONS *
0225 * R5 = # OF VERT POSITIONS *
0226 * R9 = PATTERN # OFFSET *
0227 *
0228 *****
0229 *
0230 *
0231 00FC 0201 DBOX LI R1,>9000 ADDRESS OF DATA TO 9918
00FE 9000
0232 0100 0202 LI R2,>9002 ADDRESS OF ADDRESSES TO 9918
0102 9002
0233 0104 C483 MOV R3,*R2 SEND LSB OF ADDRESS TO 9918
0234 0106 06C3 SWPB R3 REVERSE BYTES
0235 0108 C483 MOV R3,*R2 SEND MSB OF ADDRESS TO 9918
0236 010A 06C3 SWPB R3 REVERSE BYTES
0237 010C C189 MOV R9,R6 GET OFFSET
0238 010E 0226 AI R6,>01 POINT TO UPPER LEFT CORNER PATTE
0110 0001
0239 0112 C446 MOV R6,*R1 SEND IT TO THE 9918
0240 0114 C1C4 MOV R4,R7 STORE HORIZ COUNT IN TEMP REG
0241 0116 0647 DECT R7 DETERMINE (LENGTH - CORNERS)
0242 0118 1304 JEQ DBL2 NO LENGTH OTHER THAN CORNERS
0243 011A C189 MOV R9,R6 PATTERN 00 + OFFSET
0244 011C C446 DBL1 MOV R6,*R1 SEND LINE SEGMENT TO 9918
0245 011E 0607 DEC R7 DEC LINE COUNT
0246 0120 16FD JNE DBL1 NOT DONE YET, GO AGAIN
0247 0122 C189 DBL2 MOV R9,R6 GET OFFSET
0248 0124 0226 AI R6,>05 POINT TO UPPER RIGHT CORNER
0126 0005
0249 0128 C446 MOV R6,*R1 SEND IT TO 9918
0250 012A C203 MOV R3,R8 SEND ADDRESS OF UPPER LEFT TO TE
0251 012C C1C5 MOV R5,R7 SEND VERT COUNT TO TEMP
0252 012E 0647 DECT R7 DETERMINE (HEIGHT - CORNERS)
0253 0130 130C JEQ DBL4 NO HEIGHT OTHER THAN CORNERS
0254 0132 C189 MOV R9,R6 GET OFFSET
0255 0134 0226 AI R6,>03 POINT TO VERT LINE PATTERN
0136 0003
0256 0138 0228 DBL3 AI R8,>20 INC VERT POSITION BY 1 CHAR
013A 0020
0257 013C C488 MOV R8,*R2 SEND ADDRESS TO 9918
0258 013E 06C8 SWPB R8 REVERSE BYTES
0259 0140 C488 MOV R8,*R2 SEND ADDRESS TO 9918
0260 0142 06C8 SWPB R8 REVERSE BYTES
0261 0144 C046 MOV R6,R1 SEND VERT LINE SEGMENT TO 9918
0262 0146 0607 DEC R7 DECREMENT VERT COUNT
0263 0148 16FD JNE DBL3 NOT DONE YET, GO AGAIN

```

```

0264 014A 0228 DBL4 AI R8,>20 INC VERT POSITION BY 1 CHAR
      014C 0020
0265 014E C488 MOV R8,*R2 SEND ADDRESS TO 9918A
0266 0150 06C8 SWPB R8 REVERSE BYTES
0267 0152 C088 MOV R8,R2 SEND ADDRESS TO 9918
0268 0154 06C8 SWPB R8 REVERSE BYTES
0269 0156 C189 MOV R9,R6 GET OFFSET
0270 0158 0226 AI R6,>02 POINT TO LOWER LEFT CORNER PATT
      015A 0002
0271 015C C446 MOV R6,*R1 SEND IT TO 9918
0272 015E C1C4 MOV R4,R7 SEND HORIZ COUNT TO TEMP
0273 0160 0647 DECT R7 DETERMINE (HORIZ - CORNERS)
0274 0162 1304 JEQ DBL6 NO HORIZ OTHER THAN CORNERS
0275 0164 C189 MOV R9,R6 GET OFFSET
0276 0166 C446 DBL5 MOV R6,*R1 SEND HORIZ PATTERN TO 9918
0277 0168 0607 DEC R7 DECREMENT HORIZ COUNT
0278 016A 16FD JNE DBL5 IF NOT DONE, GO AGAIN
0279 016C C189 DBL6 MOV R9,R6 GET OFFSET
0280 016E 0226 AI R6,>04 POINT TO LOWER RIGHT PATTERN
      0170 0004
0281 0172 C446 MOV R6,*R1 SEND PATTERN TO 9918
0282 0174 C1C5 MOV R5,R7 STORE VERT COUNT IN TEMP
0283 0176 0647 DECT R7 DECREMENT VERT COUNT
0284 0178 1312 JEQ DBL8 IF NO VERT SEGMENTS, DONE
0285 017A C1C4 MOV R4,R7 STORE HORIZ COUNT IN TEMP
0286 017C 0607 DEC R7 DECREMENT HORIZ COUNT
0287 017E C203 MOV R3,R8 STORE ADDRESS OF UPPER LEFT COR
0288 0180 A207 A R7,R8 FIND UPPER RIGHT CORNER LOCATION
0289 0182 C189 MOV R9,R6 GET OFFSET
0290 0184 0226 AI R6,>03 POINT TO VERTICAL LINE PATTERN
      0186 0003
0291 0188 C1C5 MOV R5,R7 STORE VERT COUNT IN TEMP
0292 018A 0647 DECT R7 DETERMINE (HEIGHT - CORNERS)
0293 018C 0228 DBL7 AI R8,>20 INCREMENT VERT POSITION BY 1 CHA
      018E 0020
0294 0190 C488 MOV R8,*R2 SEND ADDRESS TO 9918
0295 0192 06C8 SWPB R8 REVERSE BYTES
0296 0194 C488 MOV R8,*R2 SEND ADDRESS TO 9918
0297 0196 06C8 SWPB R8 REVERSE BYTES
0298 0198 C446 MOV R6,*R1 SEND PATTERN TO 9918
0299 019A 0607 DEC R7 DECREMENT VERT COUNT
0300 019C 16F7 JNE DBL7 IF NOT DONE, GO AGAIN
0301 019E 045B DBL8 B *R11 SUB DONE RETURN TO CALLING PROG
0302 *
0303 *
0304 *****
0305 * *
0306 * LOAD TEXT COLORS SUBROUTINE *
0307 * *
0308 * REGISTERS USED: *
0309 * *
0310 * R4 = COLORS FOR TEXT CHARACTERS *
0311 * *
0312 *****
0313 *
0314 01A0 0201 LDTC LI R1,>9000
      01A2 9000
0315 01A4 0202 LI R2,>9002
      01A6 9002
0316 01A8 0203 LI R3,>4204 ADDRESS FOR TEXT COLORS IN 9918

```

```

01AA 4204
0317 01AC C483      MOV R3,*R2      SEND ADDRESS TO 9918
0318 01AE 06C3      SWPB R3        REVERSE BYTES
0319 01B0 C483      MOV R3,*R2      8 COLOR CHAR X 8 TEXT/CHAR = 64
0320 01B2 C444      LCLI MOV R4,*R1  SEND WORD TO 9918
0321 01B4 0602      DEC R2         DECREMENT COUNT
0322 01B6 16FD      JNE LCLI       IF NOT DONE, GO AGAIN
0323 01B8 045B      B *R11        DONE, RETURN TO CALLING PROG
0324 *
0325 *
0326 *****
0327 *
0328 *           DRAW A VERTICAL LINE SUB
0329 *
0330 *   REGISTERS USED:
0331 *
0332 *   R3 = ADDRESS ON SCREEN
0333 *   R4 = # OF POSITIONS
0334 *   R9 = PATTERN OFFSET
0335 *
0336 *****
0337 *
0338 01BA C483      DVLN MOV R3,*R2      SEND ADDRESS TO 9918
0339 01BC 06C3      SWPB R3        REVERSE BYTES
0340 01BE C483      MOV R3,*R2      SEND ADDRESS TO 9918
0341 01C0 06C3      SWPB R3        REVERSE BYTES
0342 01C2 C445      MOV R5,*R1      SEND PATTERN TO 9918
0343      END
NO ERRORS,      NO WARNINGS

```

5. TMS9918A/9928A/9929A ELECTRICAL SPECIFICATIONS

5.1 ABSOLUTE MAXIMUM RATINGS OVER OPERATING FREE-AIR TEMPERATURE RANGE

(unless otherwise noted)*

Supply voltage, V_{CC}	-0.3 to 20 V
All input voltages	-0.3 to 20 V
Output voltage	-2 to 7 V
Continuous power dissipation	1.3 W
Operating free-air temperature range	0°C to 70°C
Storage temperature range	-55°C to +150°C

*Stresses beyond those listed under Absolute Maximum Ratings may cause permanent damage to the device. This is a stress rating only and functional operation of the device at these or any other conditions beyond those indicated in the Recommended Operating Conditions section of this specification is not implied. Exposure to absolute maximum rated conditions for extended periods may affect device reliability.

5.2 RECOMMENDED OPERATING CONDITIONS*

PARAMETER		MIN	NOM	MAX	UNIT
Supply voltage, V_{CC}		4.75		5.25	V
Supply voltage, V_{SS}			0		V
Input Voltage, V_I , $\overline{\text{RESET}}/\text{SYNC}$ pin	SYNC active	10		12	V
	RESET active			0.6	V
	SYNC and RESET inactive	3		6	V
High-level input, V_{IH}	XTAL1, XTAL2	2.75			V
	All other inputs	2.2			V
Input voltage, V_I , EXT VDP pin (TMS9918A only)	SYNC level		2.6		V
	White level		3.7		V
	Black level		3		V
Low-level input voltage, V_{IL}				0.8	V
Operating free-air temperature, T_A		0		70	°C

* All voltage values are with respect to V_{SS} .

5.3 ELECTRICAL CHARACTERISTICS OVER FULL RANGES OF RECOMMENDED OPERATING CONDITIONS (unless otherwise noted)

TMS9918A/9928A/9929A

PARAMETER		TEST CONDITIONS	MIN	TYP†	MAX	UNIT
V _{OH}	High-level output voltage	I _{OH} = 400 μA	2.7	3.4		V
			All other outputs	2.4	3.2	
V _{OL}	Low-level output voltage	I _{OL} = 1.2 mA		0.3	0.6	V
		I _{OL} = 800 μA			0.6	
I _{OZH}	Off-state output current high-level voltage applied, D0-D7 outputs	V _O = 5.25 V		1	100	μA
I _{OZL}	Off-state output current high-level voltage applied, D0-D7 outputs	V _O = 0.4 V		1	-100	μA
I _{IH}	High-level input current	V _I = 5.25 V, all other pins at 0 V			10	μA
I _{IL}	Low-level input current	V _I = 0 V, All other pins at 0 V			-10	μA

TMS9918A Only (Figure 5-1)

PARAMETER		TEST CONDITIONS	MIN	NOM	MAX	UNIT
V _{white}	Video voltage level of white, COMVID	R _L = 470 Ω	2.8	3.0	3.2 V	
V _{black}	Video voltage level of black (blank), COMVID		2.1	2.3	2.5 V	
V _{sync}	Video voltage level of sync, COMVID		1.85	2.0	2.1 V	

† All typical values are at V_{CC} = 5.25 V, T_A = 25°C.

5.3 ELECTRICAL CHARACTERISTICS OVER FULL RANGES OF RECOMMENDED OPERATING CONDITIONS (unless otherwise noted) (Continued)

TMS9928A/9929A Only (Figure 5-1)

PARAMETER		TEST CONDITIONS	MIN	NOM	MAX	UNIT
V _{white}	Video voltage level of white, Y, R-Y, B-Y outputs	R _L = 470 Ω	2.5	3	3.6	V
V _{black}	Video voltage level of black (blank), Y, R-Y, B-Y outputs		1.6	2.3	2.5	V
V _{sync}	Video voltage level of sync, Y output		1.2	1.8	2	V

TMS9929A Only

PARAMETER		TEST CONDITIONS	MIN	TYP	MAX	UNIT
V _{PS}	Color burst video voltage level with respect to V no color	R-Y output		0.25		V
V _{neg}	Color burst video voltage level with respect to V no color	B-Y output		-0.25		V

TMS9918A/9928A/9929A (Figure 5-2)

PARAMETER		TEST CONDITIONS	MIN	NOM	MAX	UNIT
Video voltage difference, white-black, Y, R-Y, B-Y outputs			0.7	1.0		V
I _{CC}	Average supply current from V _{CC}	T _A = 25°C		200	250	mA
C _i	Input capacitance	D0-D7	unmeasured f = 11 MHz, pins at 0 V		20	pF
		All other inputs			10	
C _O	Output capacitance	unmeasured f = 11 MHz, pins at 0 V			20	pF

† All typical values are at V_{CC} = 5.25 V, T_A = 25°C.

**TIMING REQUIREMENTS OVER FULL RANGES OF RECOMMENDED OPERATING CONDITIONS
(TMS9918A/9928A/9929A)**
CPU - VDP Interface (Figures 5-3 and 5-4)

PARAMETER		MIN	NOM	MAX	UNIT
$t_{su}(A-RL)$	Address setup time before CSR low		0		ns
$t_{su}(A-WL)$	Address setup time before CSW low		30		ns
$t_h(WL-A)$	Address hold time after CSW low		30		ns
$t_{su}(D-WH)$	Data setup time before CSW high		100		ns
$t_h(WH-D)$	Data hold time after CSW high		30		ns
$t_w(WL)$	Pulse width, CSW low		200		ns
$t_w(CS-H1)$	Pulse width, chip select high (requesting memory access)		8		μs
$t_w(CS-H2)$	Pulse width, chip select high (not requesting memory access)		2		μs

VDP-VRAM Interface (Figure 5-5 and 5-6)

PARAMETER		MIN	NOM	MAX	UNIT
t_c	Memory read or write cycle time	372			ns
$t_{su}(D-CH)$	Input data setup time before CAS high	60			ns
$t_h(CH-D)$	Input data hold time after CAS high	0			ns

External Clock Source (Figure 5-7)

PARAMETER		MIN	TYP	MAX	UNIT
f_{ext}	External source frequency	10.738098	10.738635	10.739172	MHz
t_r/t_f	External source rise/fall time		10	15	ns
t_{wH}	External source high-level pulse width	42	47	52	ns
t_{wL}	External source low-level pulse width	42	47	52	ns
t_{pD}	External source phase delay from XTAL1 falling edge to XTAL2 falling edge	42	47	52	ns

5.5 SWITCHING CHARACTERISTICS OVER FULL RANGE OF RECOMMENDED OPERATING CONDITIONS
(TMS9918A/9928A/9929A)

CPU-VDP Interface

PARAMETER		TEST CONDITIONS	MIN	TYP	MAX	UNIT	
$T_{A(CSR)}$	Data access time from CSR low	$C_L = 300 \text{ pF}$		100	150	ns	
t_{PVX}	Data disable time after CSR high			65	100	ns	
$t_{PVX,A}$	Data invalid time from address changes			0		ns	
f_{CPUCLK}	CPU clock output clock frequency ($f_{ext} \div 3$)			3.4	3.58	3.76	MHz
$f_{GROMCLK}$	GROM clock output clock frequency ($f_{ext} \div 24$)			425.12	447.5	469.88	kHz

VDP-VRAM Interface (Figures 5-5 and 5-6)

PARAMETER		TEST CONDITIONS	MIN	TYP	MAX	UNIT
t_w	Pulse width, \overline{CAS} high	$C_L = 50 \text{ pF}$	80	100	120	ns
$t_w(CL)$	Pulse width, \overline{CAS} low		220	230	250	ns
$t_w(RH)$	Pulse width, \overline{RAS} high		100	125	150	ns
$t_w(RL)$	Pulse width, \overline{RAS} low		190	210	230	ns
$t_w(W)$	Pulse width, write pulse		170	190	210	ns
t_{CA-CL}	Delay time, column address to \overline{CAS} low		-10	-2		ns
t_{RA-RL}	Delay time, row address to \overline{RAS} low		25	45	65	ns
t_{d-WL}	Delay time, data to R/\overline{W} low		0	6	20	ns
t_{WH-CL}	Delay time, R/\overline{W} high to \overline{CAS} low		25	50	75	ns
t_{W-CH}	Delay time, R/\overline{W} low to \overline{CAS} high		120	140	160	ns
t_{W-RH}	Delay time, R/\overline{W} low to \overline{RAS} high		60	75	90	ns

5.5 SWITCHING CHARACTERISTICS OVER FULL RANGE OF RECOMMENDED OPERATING CONDITIONS
(TMS9918A/9928A/9929A) (Continued)

TMS9918A Composite video output (Figures 5-8 and 5-9)

PARAMETER		TEST CONDITIONS	MIN	TYP	MAX	UNIT
tCL-CA	Column address valid after $\overline{\text{CAS}}$ low	CL = 50 pF	45	65	85	ns
tRL-RA	Row address valid after $\overline{\text{RAS}}$ low		20	25	30	ns
tRL-CA	Column address valid after $\overline{\text{RAS}}$ low		95	110	130	ns
tCL-D	Data valid after $\overline{\text{CAS}}$ low		240	260	280	ns
tRL-D	Data valid after $\overline{\text{RAS}}$ low		95	110	125	ns
tWL-D	Data valid after R/ $\overline{\text{W}}$ low		135	165	195	ns
tCH-WL	Read command valid after $\overline{\text{CAS}}$ high		0			ns
tCL-W	Write command valid after $\overline{\text{CAS}}$ low		270	290	310	ns
tCH-RL	Delay time, $\overline{\text{CAS}}$ high to $\overline{\text{RAS}}$ low		45	65		ns
tCL-RH	Delay time, $\overline{\text{CAS}}$ low to $\overline{\text{RAS}}$ high		150	170	190	ns
tRL-CL	Delay time, $\overline{\text{RAS}}$ low to $\overline{\text{CAS}}$ low		30	40	50	ns

**5.5 SWITCHING CHARACTERISTICS OVER FULL RANGE OF RECOMMENDED OPERATING CONDITIONS
(TMS9918A/9928A/9929A) (Continued)**

TMS9918A Composite video output (Figures 5-8 and 5-9)

PARAMETER		TEST CONDITIONS	MIN	TYP	MAX	UNIT
t _{fl}	Fall time, V _{black} to V _{sync}	$R_L = 470 \Omega$ $C_L = 150 \text{ pF}$		10		ns
t _{w(HS)}	Pulse width, horizontal sync			4.84		μs
t _{rl}	Rise time, V _{sync} to V _{black}			20		ns
t _{HS-CD}	Delay time, sync to color burst			372		ns
t _{w(CB)}	Width, color burst			261		μs
t _{CB-LB}	Delay time, color burst to left border			1.49		μs
t _{r2}	Rise time, V _{black} to V _{white}			60		ns
t _{w(LB)}	Left border video width			2.42		μs
t _{f2}	Fall time, V _{white} to V _{black}			110		ns
t _{w(AD)}	Width of active display area			47.68		μs
t _{w(RB)}	Right border video width			2.79		μs
t _{RB-HS}	Delay time, right border to horizontal sync			1.49		μs μs
t _{VFB}	Vertical front blanking			191.1		μs
t _{VS}	Vertical sync			191.1		μs
V _{VBB}	Vertical back blanking			828		μs
t _{ABA}	Active plus border area time			18.8		ms

NOTE: Fall times depend on external pull-down resistor

5.5 SWITCHING CHARACTERISTICS OVER FULL RANGE OF RECOMMENDED OPERATING CONDITIONS (TMS9918A/9928A/9929A) (Continued)

TMS9928A/9929A Y, R-Y, B-Y outputs (Figures 5-10 through 5-13)

PARAMETER		TEST CONDITIONS	MIN	TYP	MAX	UNIT
t _{f3}	Fall time, V _{black} to V _{sync}	$R_L = 470 \Omega$ $C_L = 15 \text{ pF}$		100		ns
t _w (HSI)	Pulse width, horizontal sync			4.84		μs
t _{r3}	Rise time, V _{sync} to V _{black}			150		ns
t _w (BP)	Width, back porch			4.47		μs
t _w (LBI)	Width, left border			2.8		μs
t _w (P)	Pulse width, pixel			186.24		ns
t _w (horz)	Width, horizontal line			63.695		μs
t _w (ADI)	Width, active display area			47.67		μs
t _{r4}	Rise time, V _{black} to V _{white}			75		ns
t _{r4}	Fall time, V _{white} to V _{black}			50		ns
t _w (RBI)	Width, right border			2.42		μs
t _w (FP)	Width, front porch			1.49		μs
t _{r5}	Rise time, V no color to V pos CB			150		ns
t _w (CB1)	Pulse width, pos color burst			2.6		μs
t _{f5}	Fall time, V pos CB to V no color			100		ns
t _w (CB-LBI)	Delay time, pos CB to left border			1.49		μs
t _{f6}	Fall time, V no color to V neg CB			100		ns
t _{r6}	Rise time, V neg CB to V no color			150		ns
t _w (VSI)	Pulse width, vertical sync			465		ns
t _v FBI	Vertical front blanking			191.09		μs
t _v SI	Vertical sync			191.09		μs
t _v BBI	Vertical back blanking			828.04		μs
t _{ABAI}	Active area plus border area total			18.70		mS
	Vertical time			19.91		mS

NOTE: Fall times depend on external pull-down resistor.

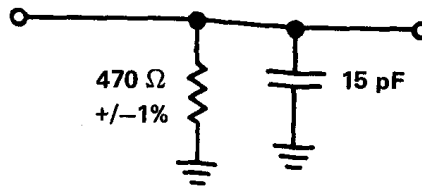

FIGURE 5-1 – LOAD CIRCUIT FOR COMVID (ALL DEVICES) AND R-Y, Y, B-Y SWITCHING CHARACTERISTICS (TMS9928A/9929A)

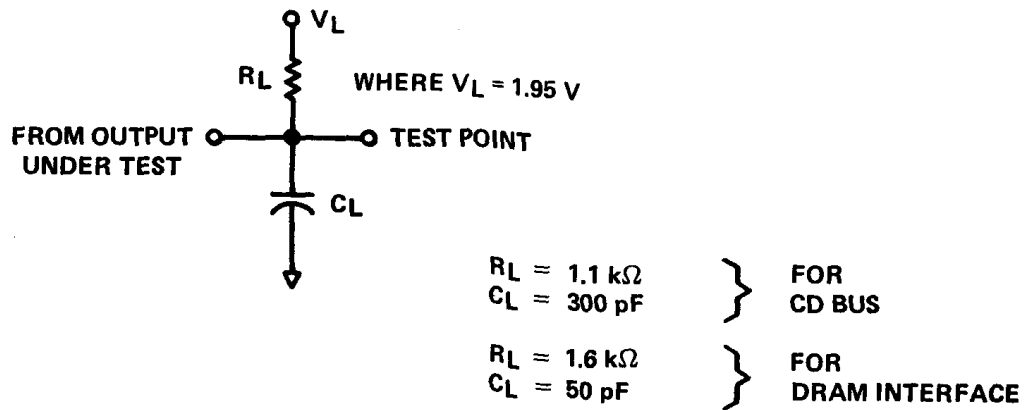

FIGURE 5-2 – LOAD CIRCUITS FOR ALL OUTPUTS EXCEPT COMVID, R-Y, Y, B-Y

WRITE CYCLE

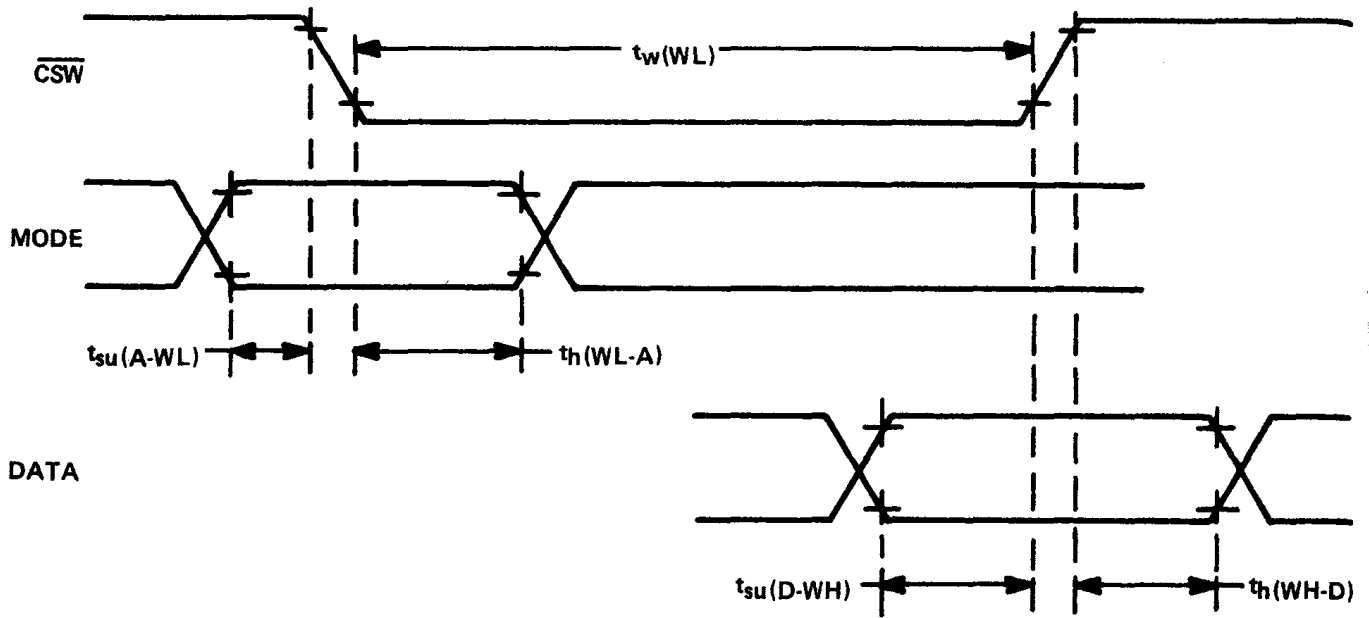
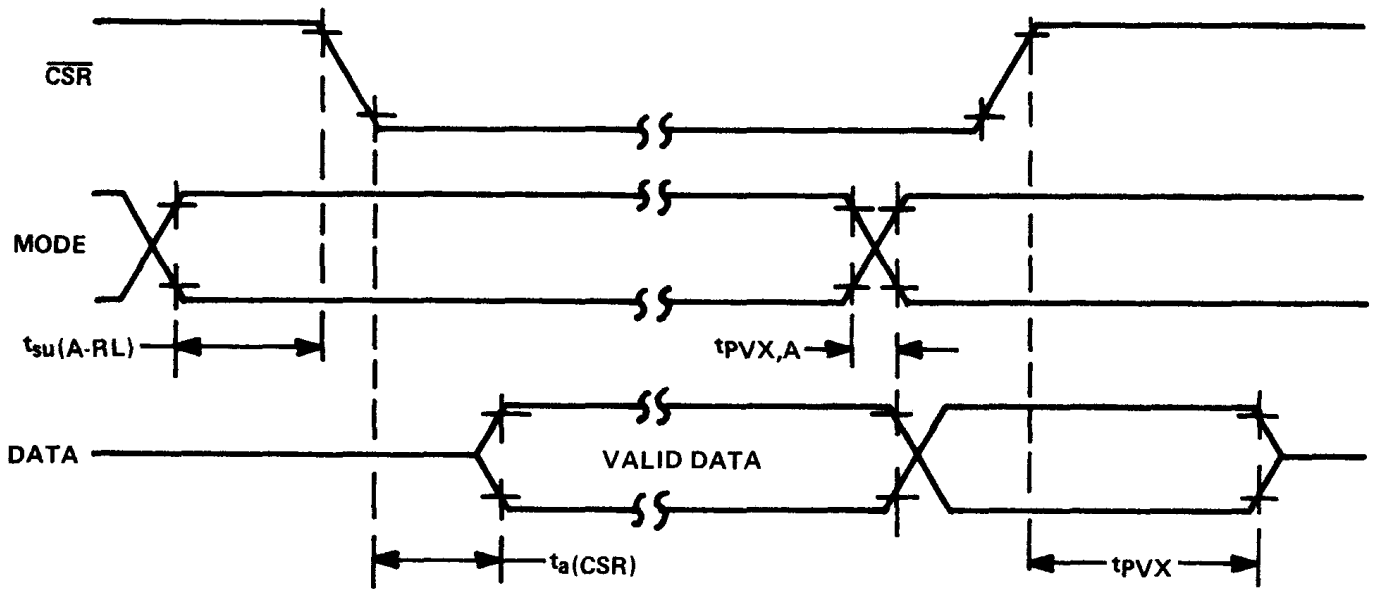

FIGURE 5-3 — CPU-VDP WRITE CYCLE FOR TMS9918A/9928A/9929A

READ CYCLE



NOTE: All measurements are made at 10% and 90% points.

FIGURE 5-4 — CPU-VDP READ CYCLE FOR TMS9918A/9928A/9929A

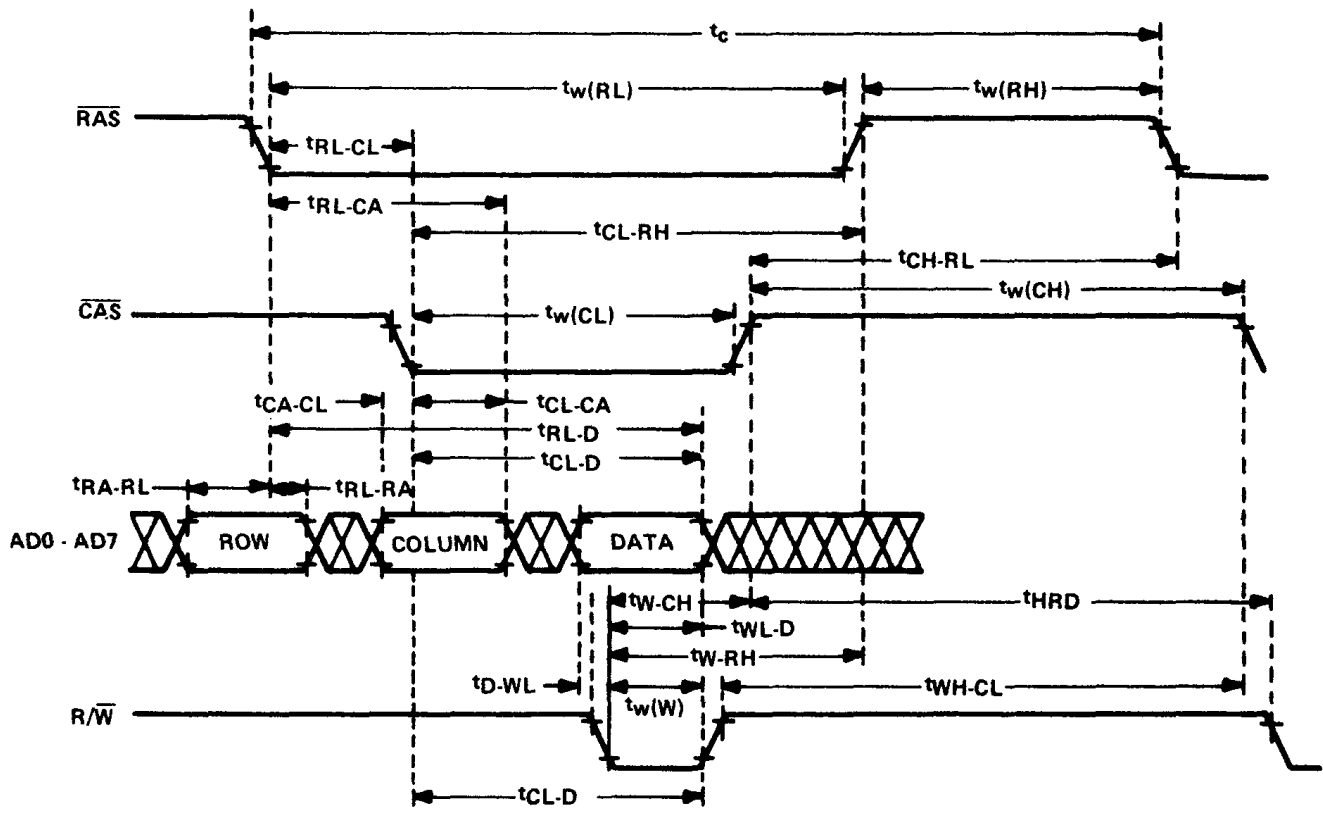
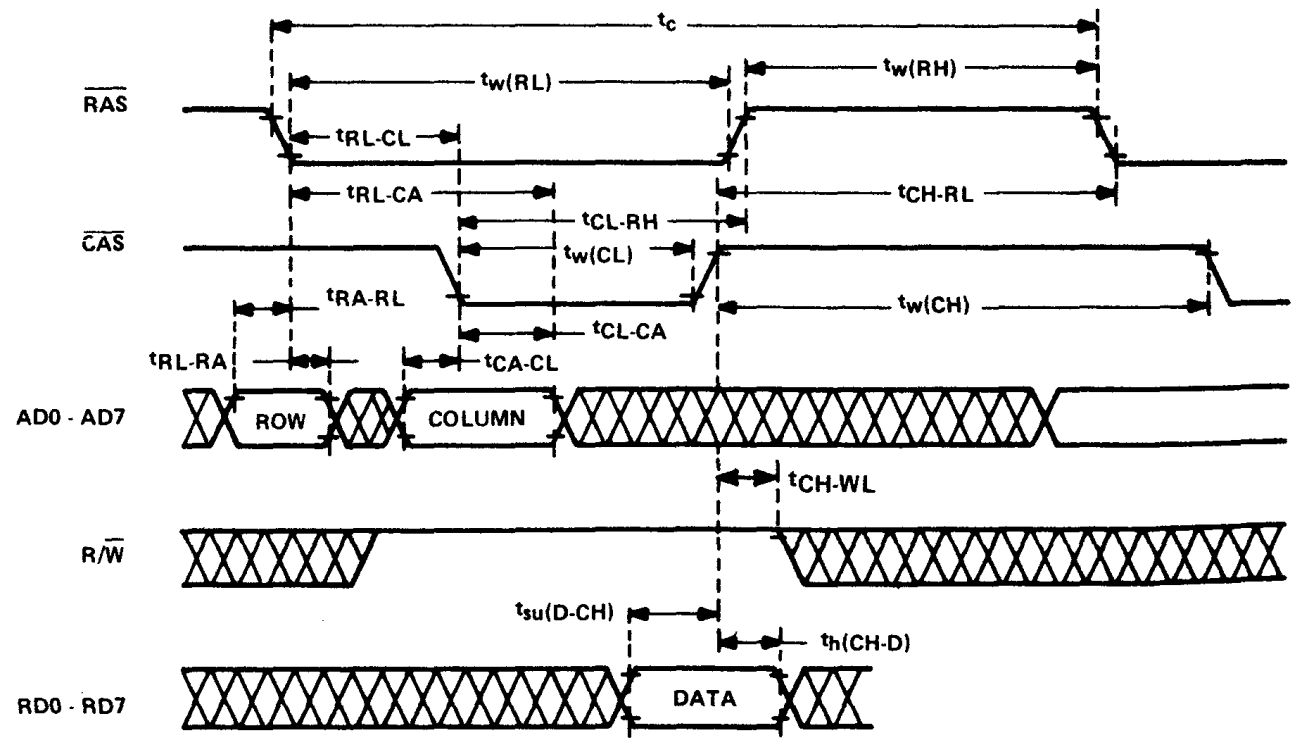
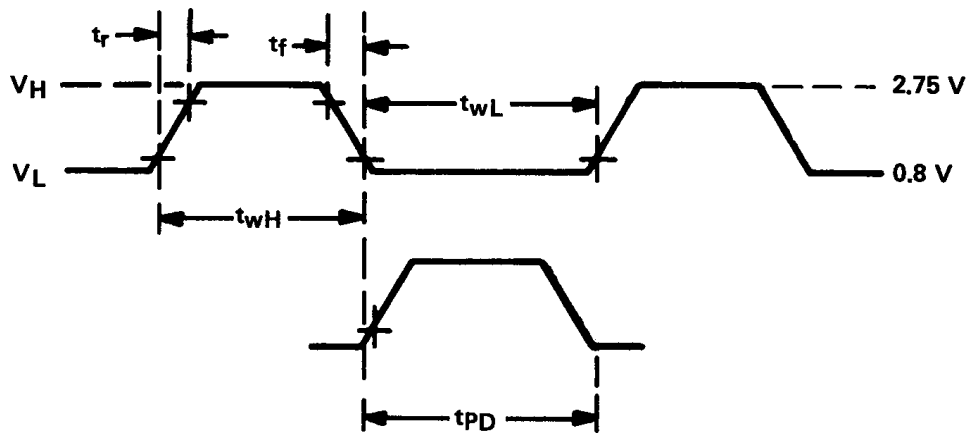

FIGURE 5-5 - VRAM WRITE CYCLE



NOTE: All measurements are made at 10% and 90% points.

FIGURE 5-6 - VRAM READ CYCLE



NOTE: All measurements are made at 10% and 90% points.

FIGURE 5-7 – EXTERNAL CLOCK TIMING WAVEFORM

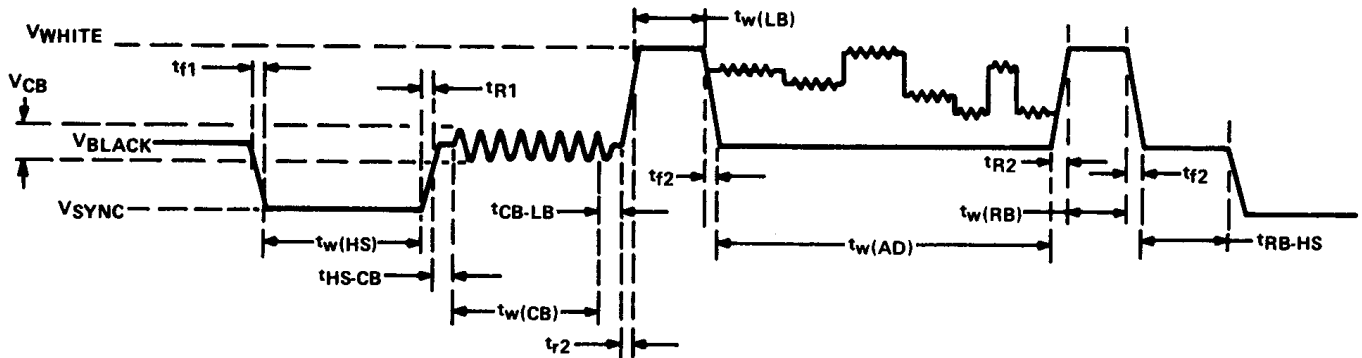
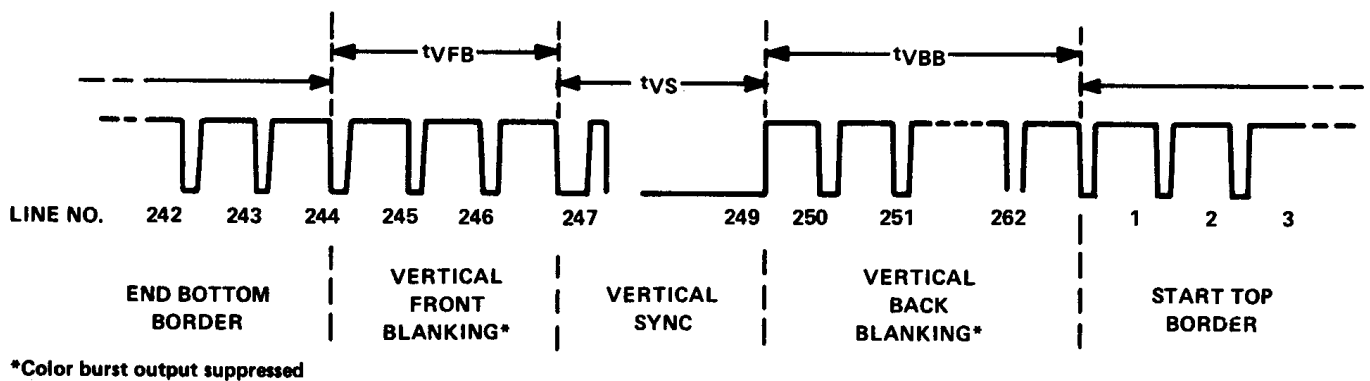

FIGURE 5-8 – TMS9918A COMVID HORIZONTAL TIMING



*Color burst output suppressed

FIGURE 5-9 – TMS9918A VERTICAL TIMING

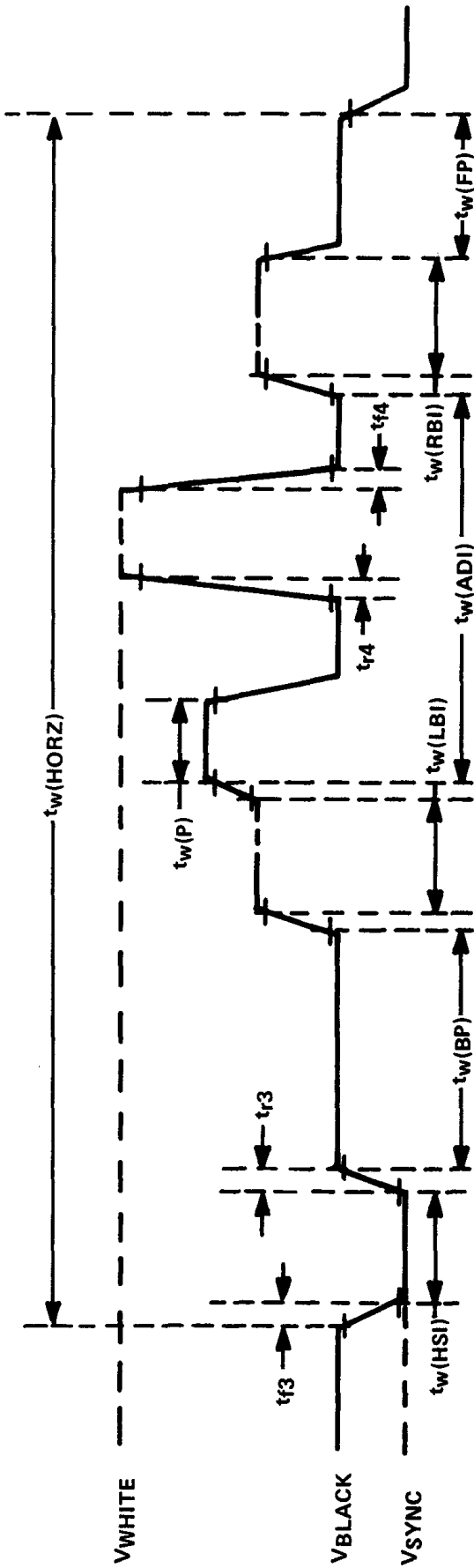

FIGURE 5-10 -- TMS9928A/9929A Y HORIZONTAL TIMING

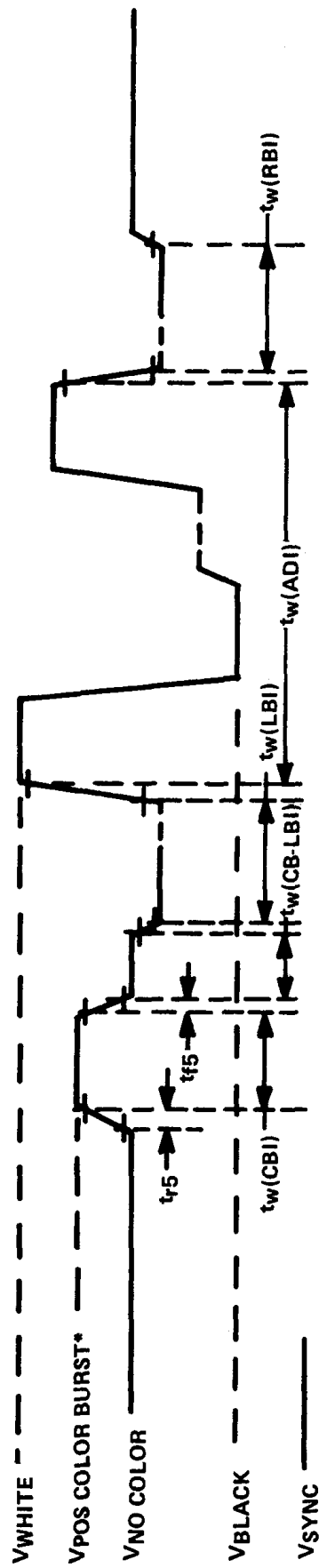
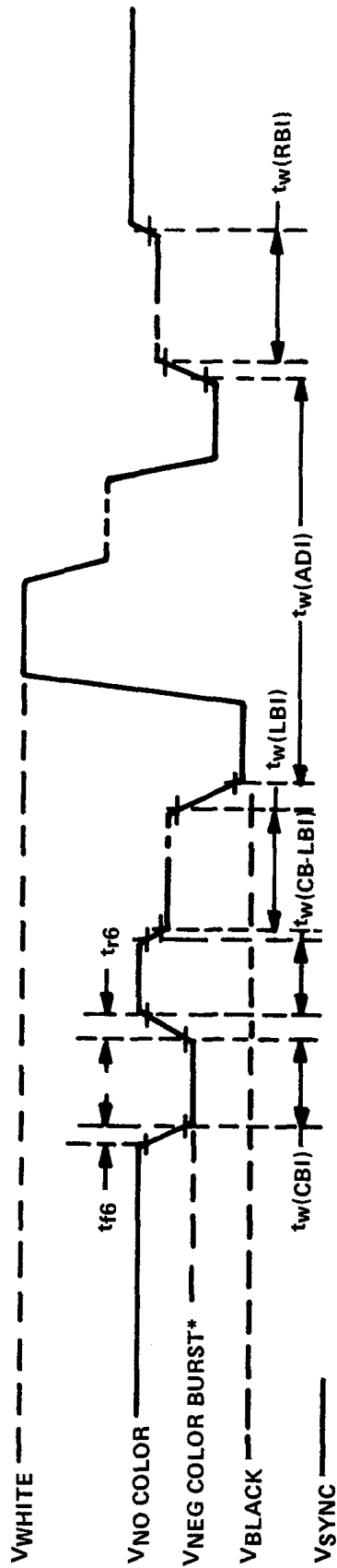

FIGURE 5-11 -- TMS9928A/9929A R-Y HORIZONTAL TIMING

* Absent for the TMS9928A



* Absent for the TMS9928A

FIGURE 5-12 — TMS9928A/9929A B-Y HORIZONTAL TIMING

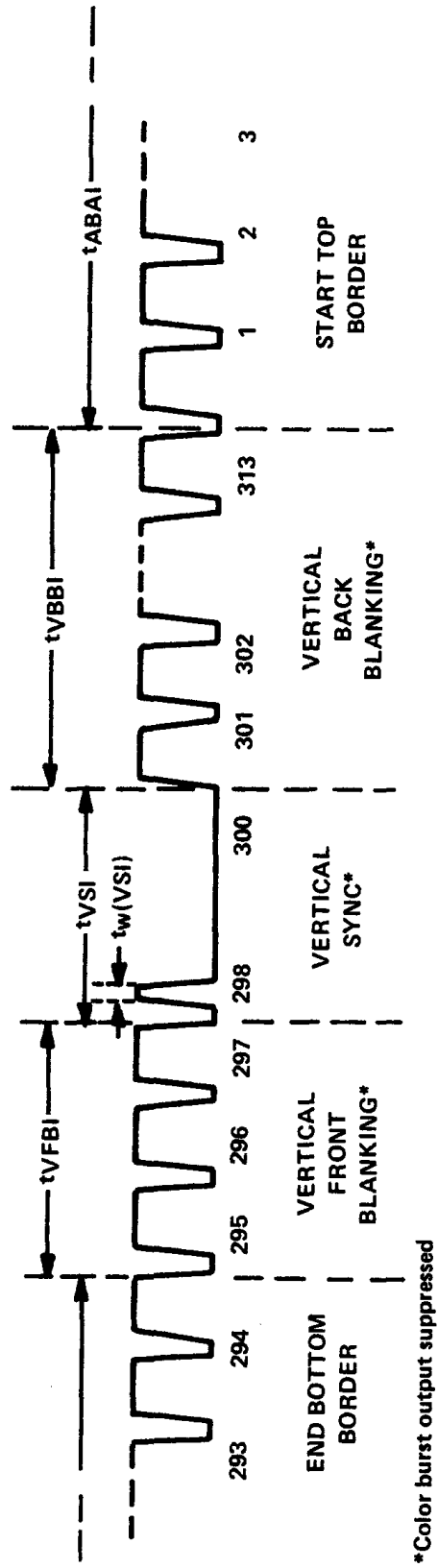
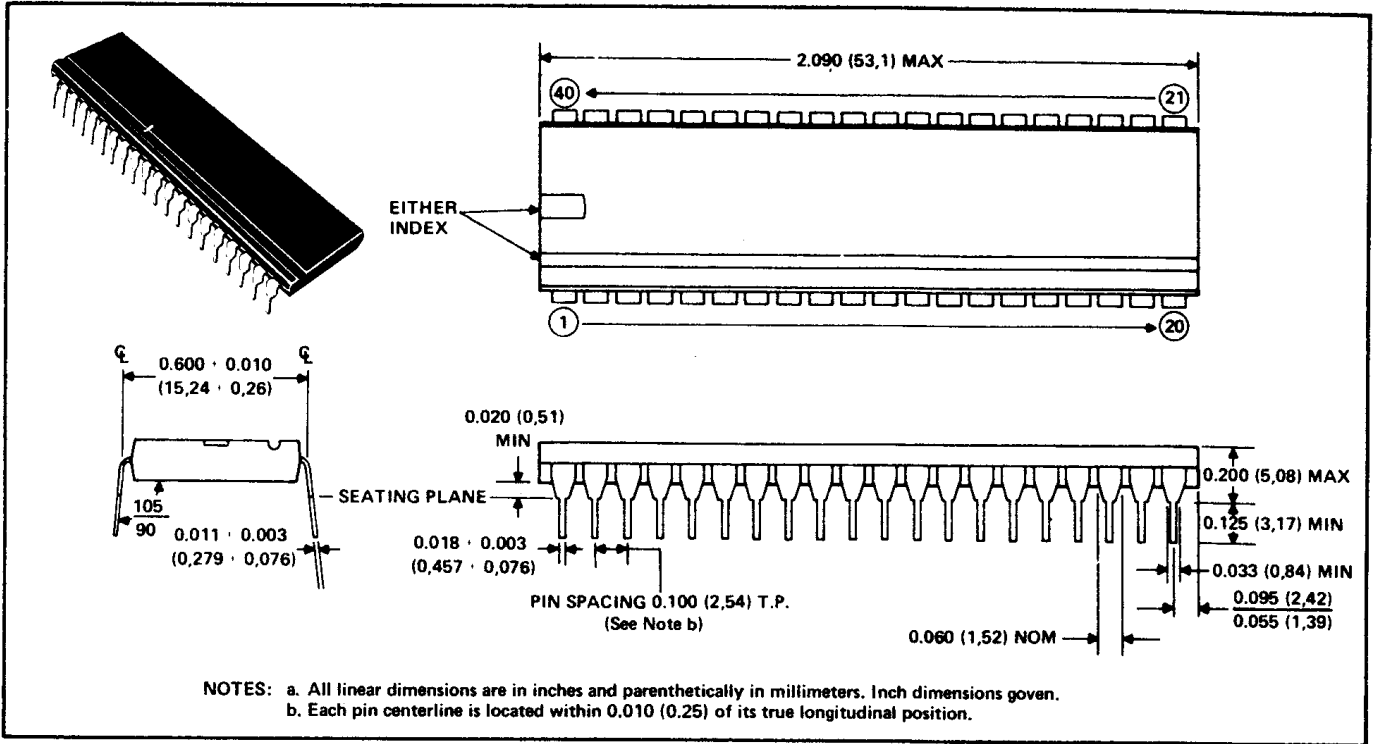

FIGURE 5-13 — TMS9929A VERTICAL TIMING

6. MECHANICAL DATA

6.1 TMS9918 40-PIN PLASTIC DUAL-IN-LINE PACKAGE



6.2 TMS9918 40-PIN CERAMIC DUAL-IN-LINE PACKAGE

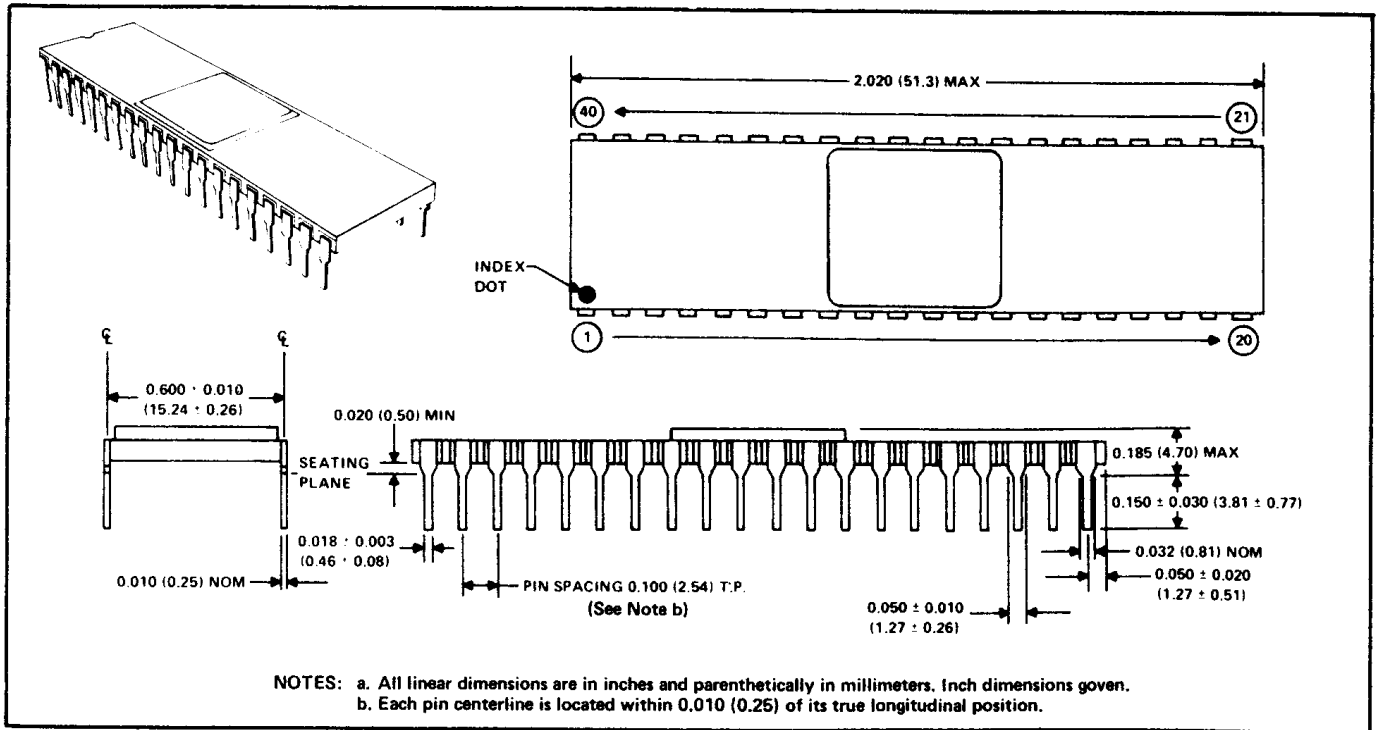

APPENDIX A

ASCII CHARACTER SET

Software programs apply to all three VDPs (TMS9918A/9928A/9929A).

This appendix contains the diagrams and software listing of an upper and lower case ASCII character set. The character matrix is 5 X 7 in the 8 X 8 pixel block. These characters are left-justified so they can be used in the text (6 X 8 pixels) mode.

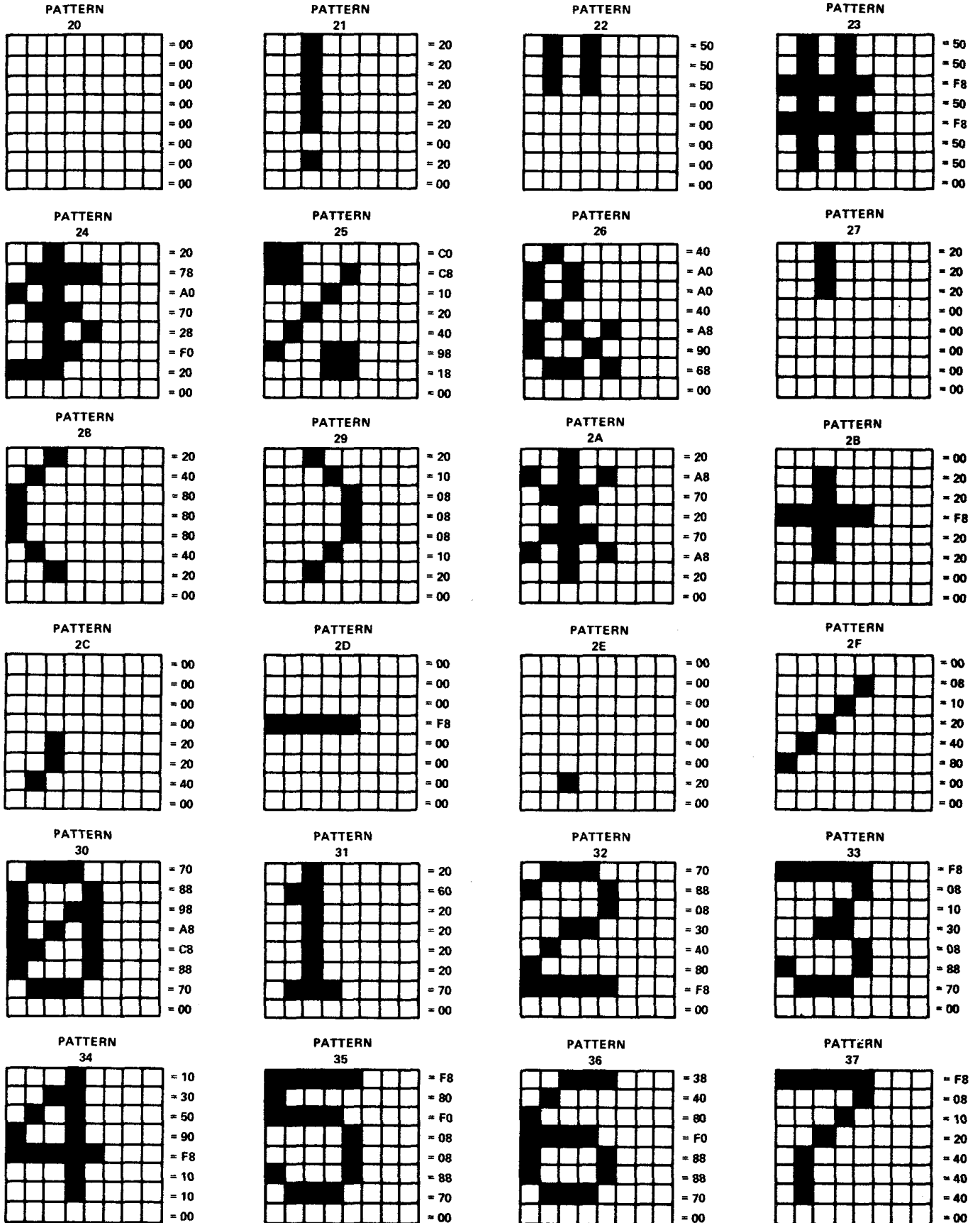

PATTERN 38

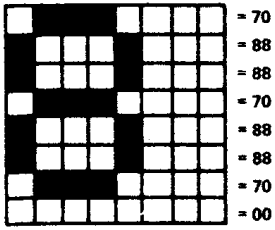

PATTERN 39

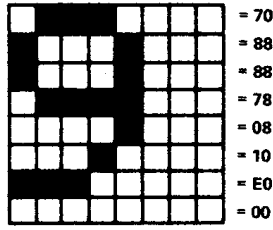

PATTERN 3A

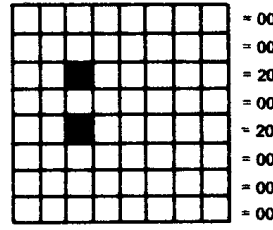

PATTERN 3B

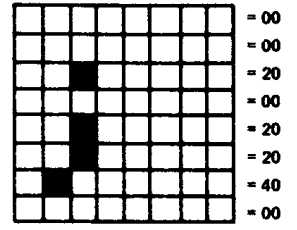

PATTERN 3C

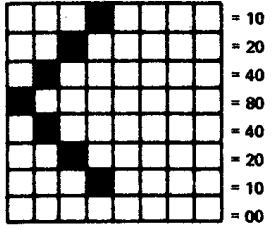

PATTERN 3D

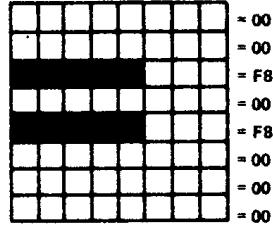

PATTERN 3E

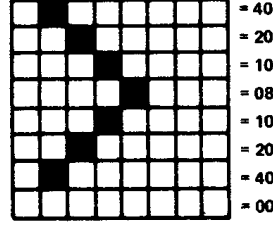

PATTERN 3F

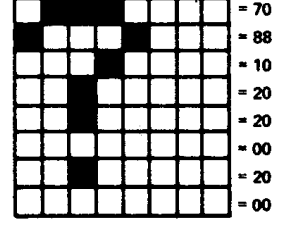

PATTERN 40

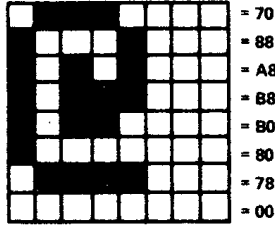

PATTERN 41

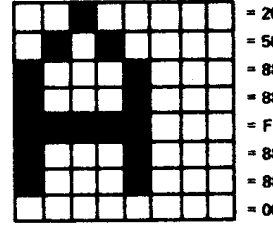

PATTERN 42

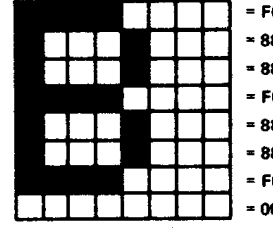

PATTERN 43

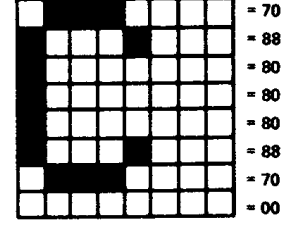

PATTERN 44

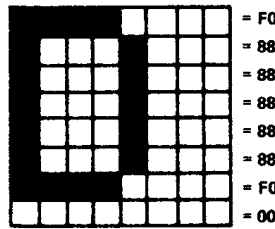

PATTERN 45

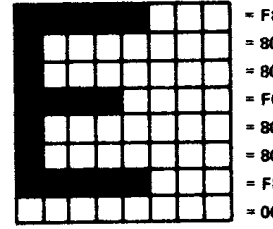

PATTERN 46

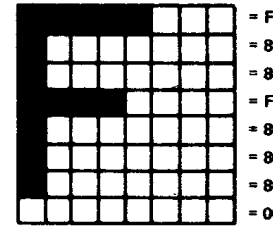

PATTERN 47

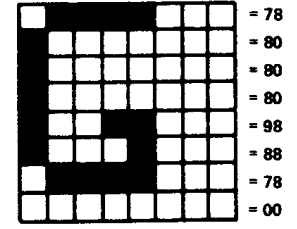

PATTERN 48

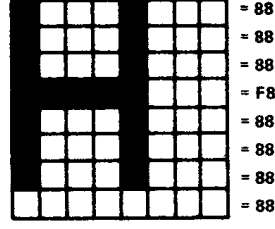

PATTERN 49

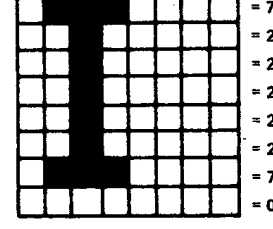

PATTERN 4A

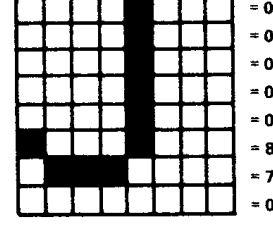

PATTERN 4B

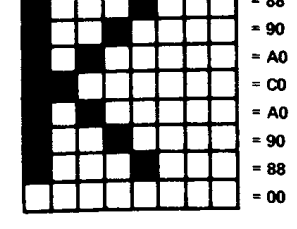

PATTERN 4C

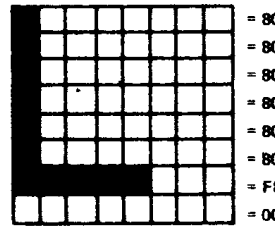

PATTERN 4D

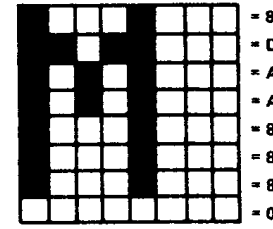

PATTERN 4E

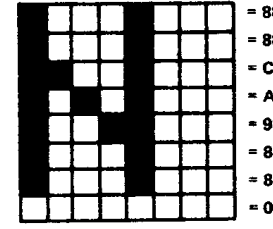

PATTERN 4F

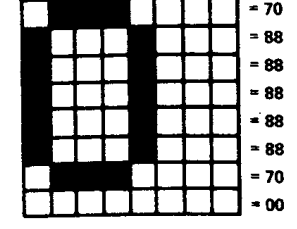

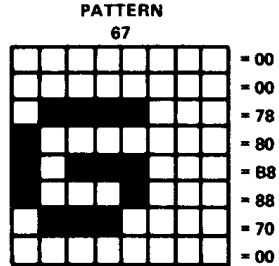
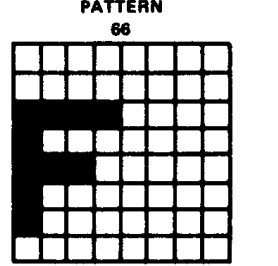
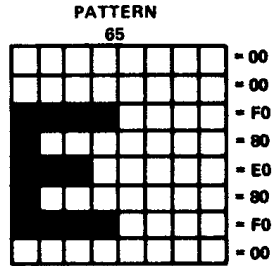
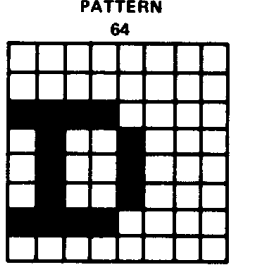
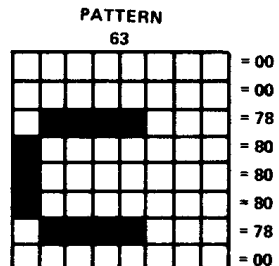
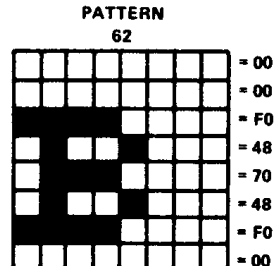
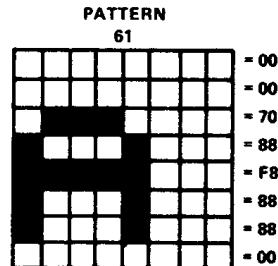
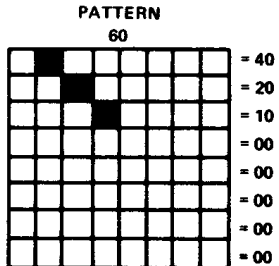
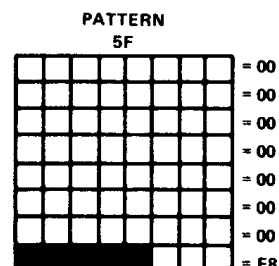
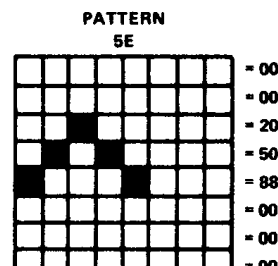
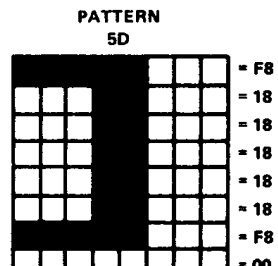
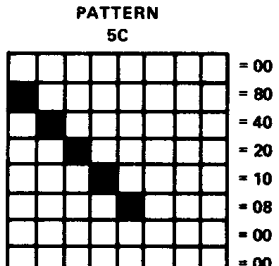
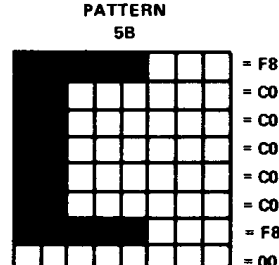
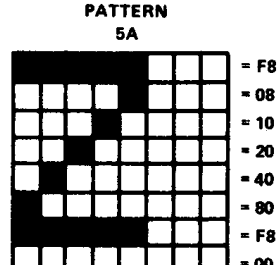
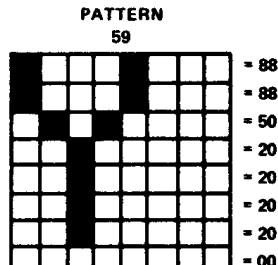
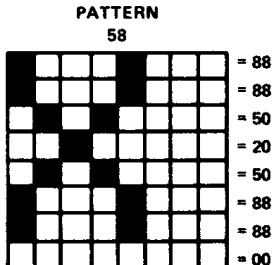
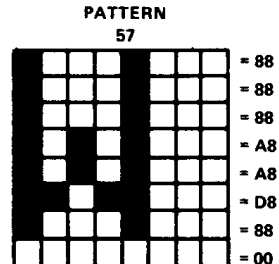
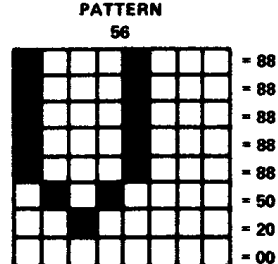
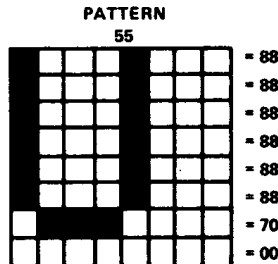
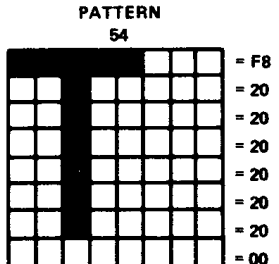
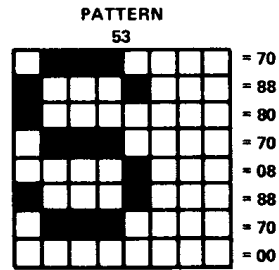
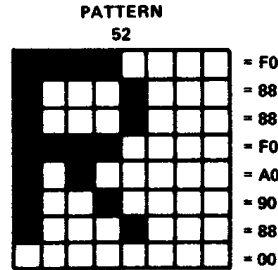
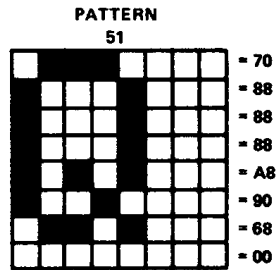
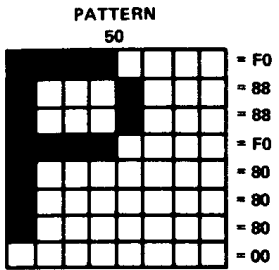

PATTERN
68

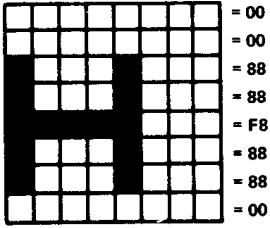

PATTERN
69

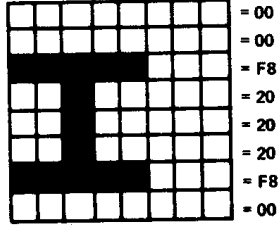

PATTERN
6A

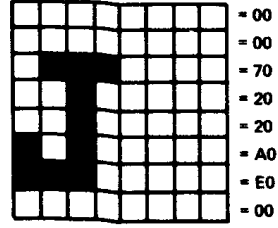

PATTERN
6B

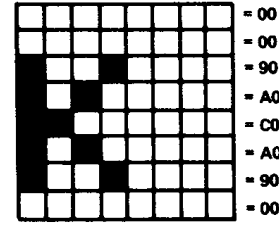

PATTERN
6C

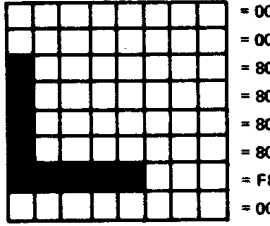

PATTERN
6D

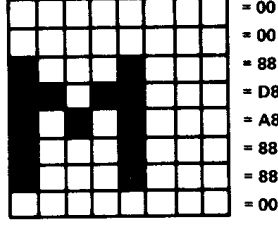

PATTERN
6E

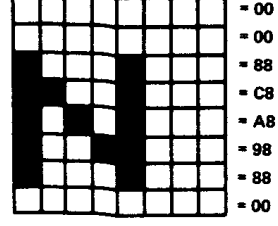

PATTERN
6F

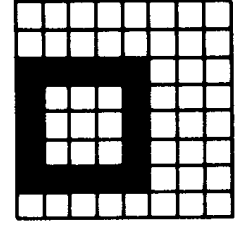

PATTERN
70

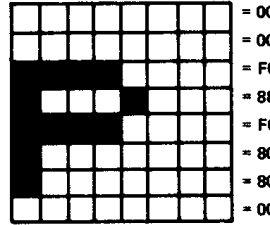

PATTERN
71

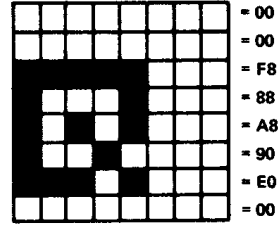

PATTERN
72

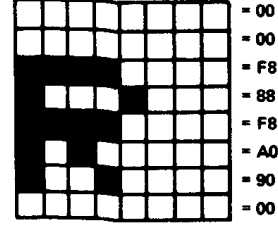

PATTERN
73

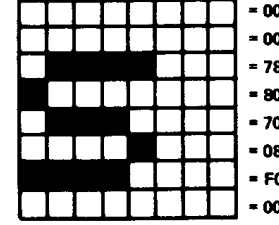

PATTERN
74

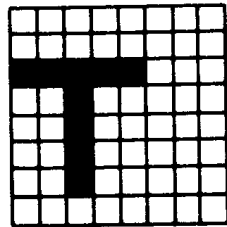

PATTERN
75

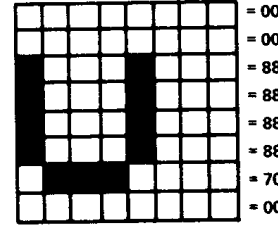

PATTERN
76

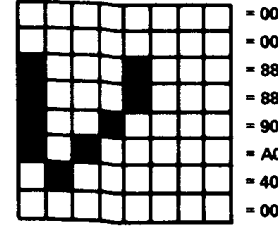

PATTERN
77

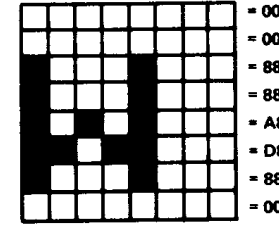

PATTERN
78

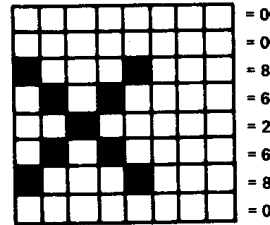

PATTERN
79

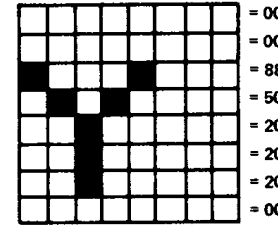

PATTERN
7A

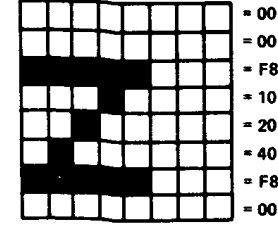

PATTERN
7B

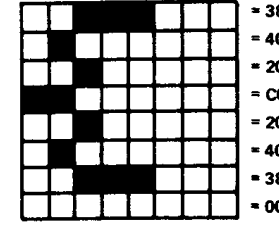

PATTERN
7C

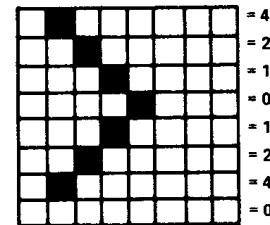

PATTERN
7D

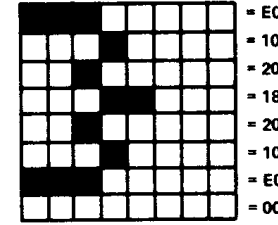

PATTERN
7E

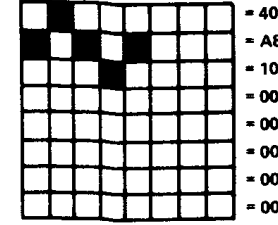

PATTERN
7F

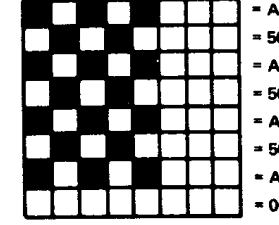

APPENDIX B

CHOOSING VRAM MEMORY

When choosing the VRAM memory, the user must take into consideration the propagation delay times of the system in addition to the access time of the memory and data setup time of the VDP.

After the VDP outputs a low level signal on $\overline{\text{RAS}}$, there is a delay time ($t_{d(\text{RAS})}$) for this low level to reach the VRAM memory; there is a similar delay ($t_{d(\text{CAS})}$) for a signal output on the $\overline{\text{CAS}}$ pin to reach the VRAM memory. Finally, there is a delay ($t_{d(\text{data})}$) for data output by the memory to reach the VDP. These delays (shown in Figure B1) depend on the length of the wires between VDP and memory, and on the capacitive load being driven.

Valid data appearing on RD0-RD7 is strobed into the VDP when $\overline{\text{CAS}}$ is brought high. Therefore, the memory chosen must have fast enough access times, $t_{a(\text{R})}$ and $t_{a(\text{C})}$, so that valid data is present on RD0-RD7 when a positive transition occurs on $\overline{\text{CAS}}$.

For 16-K memories from Texas Instruments (TMS4116-XX), the times, $t_{\text{RL-CL}}$ and $t_{a(\text{C})}$, can vary, but their sum is equal to $t_{a(\text{R})}$ ($t_{\text{RL-CL}} + t_{a(\text{C})} = t_{a(\text{R})}$). Thus, when $t_{d(\text{RAS})} \geq t_{d(\text{CAS})}$, the limiting access time is $t_{a(\text{R})}$.

After the memory receives a negative transition on the $\overline{\text{RAS}}$ input, the memory access time, $t_{a(\text{R})}$, must be fast enough so that valid data is present on RD0-RD7 when $\overline{\text{CAS}}$ goes high (see Figure B2). The equation for this is:

$$t_{\text{RL-CL}} + t_{\text{wCL}} \geq t_{d(\text{R})} + t_{d(\text{data})} + t_{\text{su(D-CH)}}$$

Under worst case conditions, this equation can be used to find out how much time is allowed for system delays using different memories.

TABLE B-1 – WORST CASE TIMING FOR VDP.

MEMORIES	SYSTEM DELAYS
t_{wCL}	230 ns MIN
$t_{\text{RL-CL}}$	40 ns MIN
$t_{\text{su(D-CH)}}$	60 ns MAX

If the values from Table B1 are placed in the equation, we find $(t_{\text{RL-CL}} + t_{\text{wCL}}) \text{ VDP MIN} \geq [(t_{d(\text{RAS})} + t_{d(\text{data})}) \text{ SYS} + t_{a(\text{R})} \text{ MEM} + t_{\text{suD-CH}} \text{ VDP MAX}]$

$$210 \text{ ns} - t_{a(\text{R})} \text{ MEM MAX} \geq [t_{d(\text{RAS})} + t_{d(\text{data})}] \text{ SYS MAX}$$

TABLE B-2 – DRAM SYSTEM DELAYS

PART NO.	$t_{a(\text{R})}$	SYSTEM DELAYS
4116-15	150 ns	60 ns MAX
4116-20	200 ns	10 ns MAX
4116-25	250 ns	-40 ns MAX

From the data given here, the VDP will work with both -15 and -20 TMS4116 dynamic RAMs provided the system delays are small enough. The VDP does not meet the $t_{a(\text{R})}$ specifications for the -25 TMS4116 and is unable to use the -25 under worst case conditions. The VDP has been verified to work with both -15 and -20 TMS4116s in a system application. Note that in addition to the equation derived above, that all memory timing requirements must be met as specified in a memory data book.

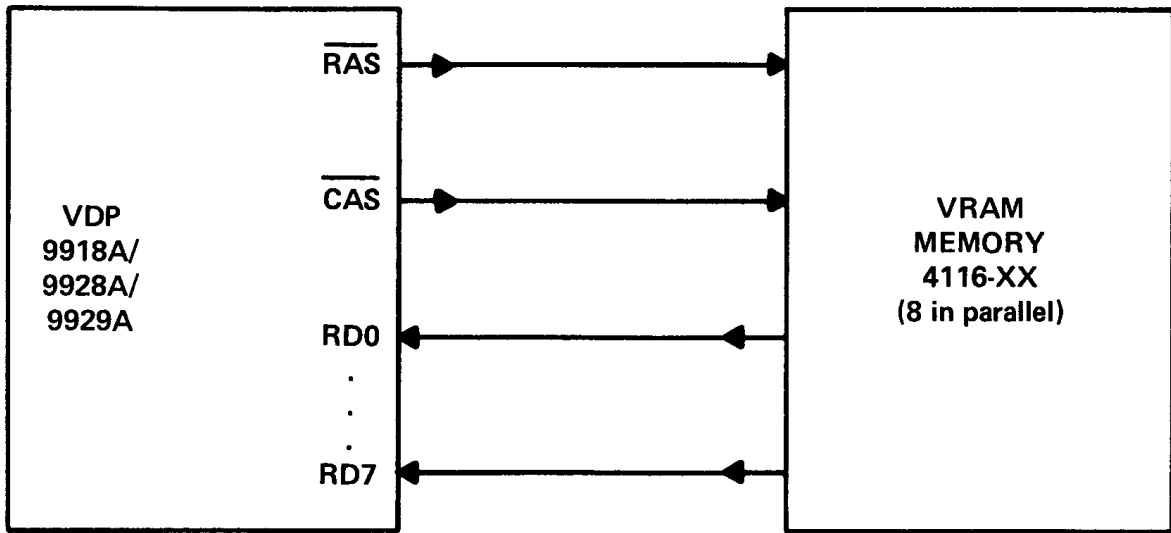

FIGURE B-1 – MEMORY CONFIGURATION SHOWING DELAY TIMES

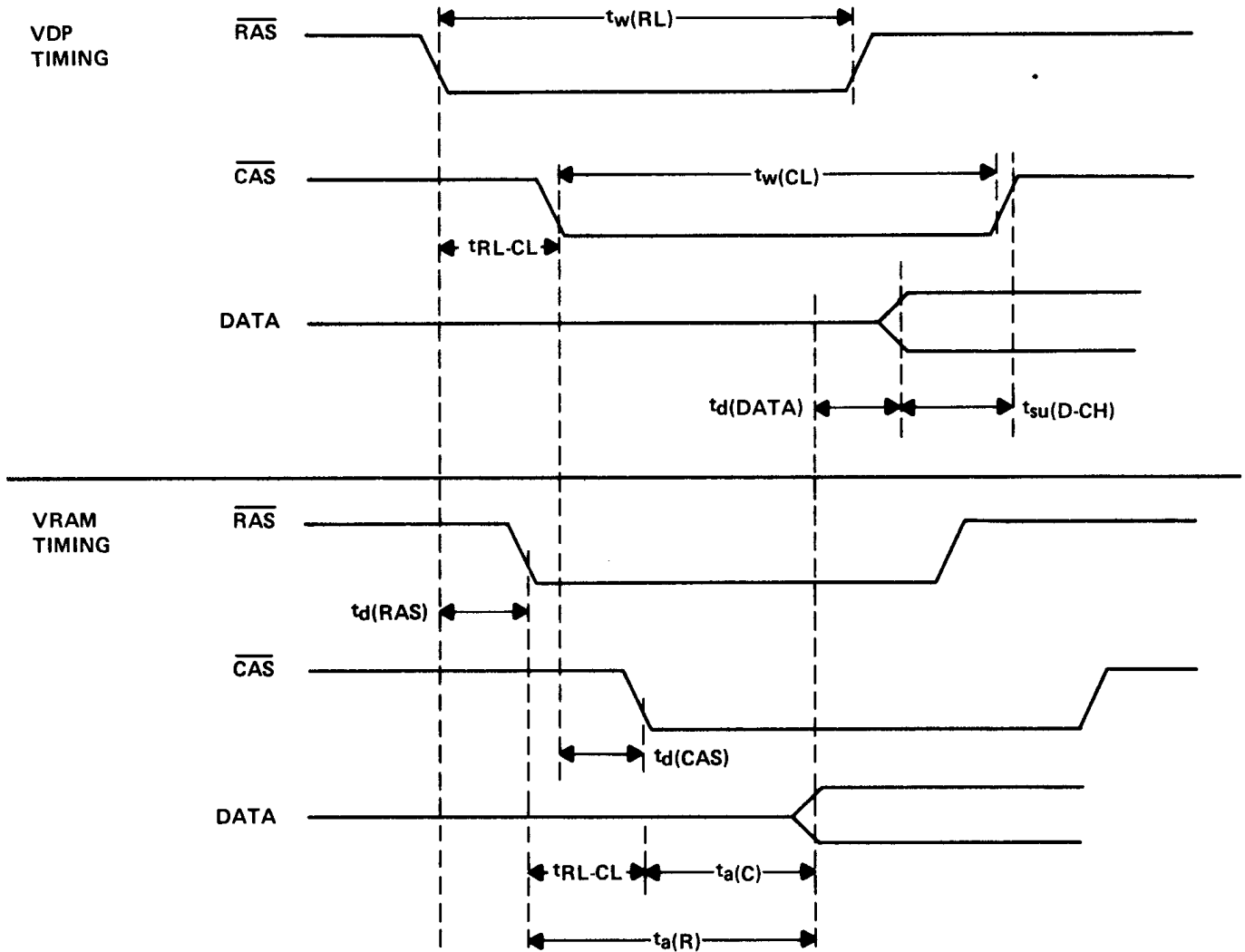
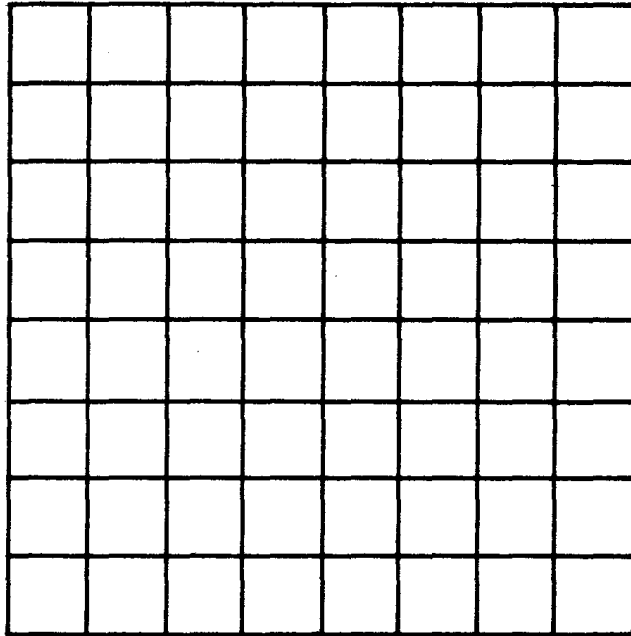

FIGURE B-2 – RELATIVE TIMING OF VRAM TO VDP

APPENDIX C
PATTERN AND SCREEN WORKSHEETS

PATTERN
NAME

PATTERN
NAME



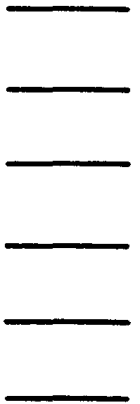
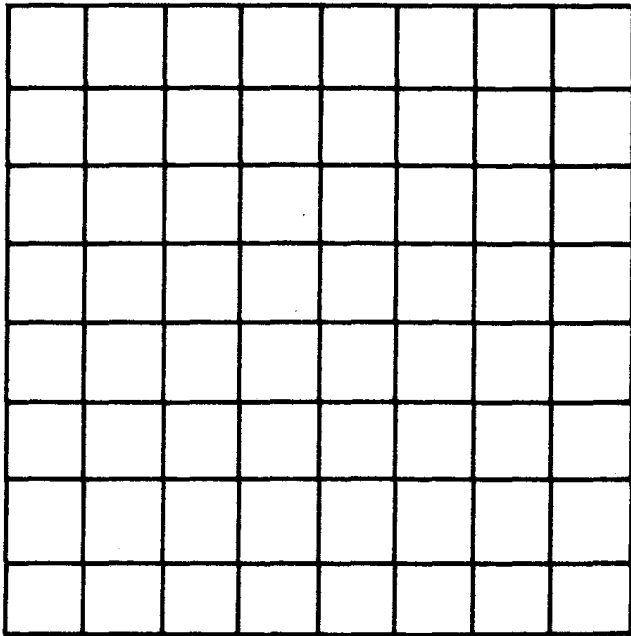

November 1982
MP010A

**TEXAS
INSTRUMENTS**

Post Office Box 1443 • Houston, Texas 77001
Semiconductor Group

Printed in U.S.A.